



*Century Bathworks*

The Innovators

# GLASSTEC PRICE LIST

973-785-4290 • 800-524-2578 • Fax 973-785-0777

# TERMS AND CONDITIONS

## **STANDARD PAYMENT TERMS:**

30 days net.

## **DEPOSIT REQUIREMENTS:**

A 50% deposit is required on all Solid Brass Enclosures. Balance is subject to standard payment terms & conditions.

## **PRICES:**

This price book includes suggested retail list prices and are effective as of May 15, 2011 All prices, discounts, quotations and specifications are subject to change without notice.

## **PAST DUE ACCOUNTS:**

Past due accounts will be placed on "hold". Orders in house will not be processed until the account is within terms.

## **SHIPMENTS/DELIVERIES:**

Customers not in Century's delivery region will be subject to minimal freight charges. Geographic areas outside of Century's delivery zones will be F.O.B. Woodland Park, NJ (or nearest Century Warehouse) and will be serviced by Common Carrier deliveries. Century will select carriers by their ability to provide quick delivery and handle our product properly with less risk of damage. Merchandise becomes the property of the purchaser who assumes full risk for loss or damage in transit once the merchandise is placed with the transportation company. We maintain the right to designate carriers, however purchaser may request his/her own carrier.

## **CANCELLATION / RETURN POLICY:**

Orders cancelled while in any stage of production shall be subject to appropriate cancellation charges or forfeiture of the deposit. Defective material only will be subject to return. Requests for a Return Goods Authorization (RGA) must be made within 60 days of the date of invoice. Items accepted for return must be properly packaged.

Glasstec/Brassline units are custom made and will not be eligible for return due to the individualized design of each enclosure.

## **WARRANTY:**

Century warrants our Glasstec enclosures to be free of defects in workmanship for a period of one (1) year. Liability on any claim of defective design and workmanship is limited to the replacement of defective material only. Century is not responsible for labor or other installation costs for the repair or replacement of defective merchandise.

Damage attributed to abuse; misuse, careless handling, alteration, improper installation or maintenance, abnormal chemical cleaning, abrasives, discoloration or stains due to improper water chemistry, or accidental damages are not covered by this warranty.

Limited Lifetime Warranty for Diamon Fusion treated glass for the lifetime of the glass as long as basic manufacturer maintenance recommendations are followed. Warranty does not cover damage attributed to abuse, careless handling, improper maintenance, harsh cleaners or chemicals containing ammonia or bleach. Company reserves the sole right of inspecting and determining warranty eligibility of merchandise. Warranty is limited to the exclusive option of the company to a full refund or expense of re-applying the Diamon Fusion and shall not be liable for the labor costs associated with replacement or remedy costs.



**Century Bathworks, Inc.™ • 250 Lackawanna Avenue • Woodland Park, NJ 07424**

**973 785 4290 • 800 524 2578 • fax 973 785 0777**

**[www.centurybathworks.com](http://www.centurybathworks.com)**

|  |                              |              |
|--|------------------------------|--------------|
| <b>Terms and Conditions</b>                  | .....                        | <b>1</b>     |
| <b>Quick Ship</b>                            | <b>QGAP, QGW, QGGP</b> ..... | <b>3-6</b>   |
| <b>Aluminum Pivot Hinge Doors</b>            | <b>GAP, GAPW</b> .....       | <b>7-10</b>  |
| <b>Brass Hinge Doors</b>                     | <b>GP</b> .....              | <b>11-12</b> |
| <b>Brass Pivot Hinge Doors</b>               | <b>GPW</b> .....             | <b>13-14</b> |
| <b>Brass Wall Mount Hinge Doors</b>          | <b>GW, GWP</b> .....         | <b>15-18</b> |
| <b>Brass Glass to Glass Hinge Doors</b>      | <b>GG, GGP</b> .....         | <b>19-22</b> |
| <b>Sliding Enclosures - Solid Brass</b>      | <b>G-CT, G-CS</b> .....      | <b>23-24</b> |
| <b>Jamb Mount, Spray Panels</b>              | <b>GWS, GSP</b> .....        | <b>25</b>    |
| <b>Steam Vents &amp; Stationary Transoms</b> | .....                        | <b>26-27</b> |
| <b>Upgrades - Glass</b>                      | .....                        | <b>28</b>    |
| <b>Upgrades - Finishes, Handles Knobs</b>    | .....                        | <b>29-30</b> |
| <b>Towel Bars, Clips</b>                     | .....                        | <b>31</b>    |
| <b>DFI, Mitered</b>                          | .....                        | <b>31</b>    |
| <b>Glass Shelving</b>                        | .....                        | <b>32</b>    |
| <b>Notes</b>                                 | .....                        | <b>33</b>    |
| <b>Locations</b>                             | .....                        | <b>34</b>    |

# QUICK SHIP

The Glasstec Quick-Ship program provides fast delivery and discounted prices on the most popular sizes in our Glasstec line. Available in models, sizes and finishes listed below using **90 Degree Stock 3/8" Clear Glass Only...**

ACTUAL MEASUREMENTS AND OUTGAGES MUST FALL WITHIN THE SIZE PARAMETERS SHOWN FOR EACH MODEL.

\*\*For Specific Door or Panel Size...Consult Factory for Availability • **DRAWINGS REQUIRED FOR ALL GLASSTEC UNITS**

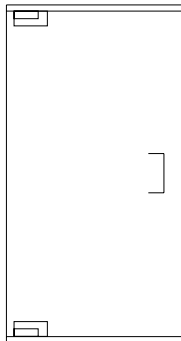

Q-GAP-70

## QGAP-70 SINGLE DOOR - ALUMINUM TOP & BOTTOM PIVOT HINGE SYSTEM ROUND DESIGNER HEADER & BASE - 6" C-PULL HANDLE STANDARD

| 72" Height         | Silver / Gold | Pearl White | Satin Chrome<br>Satin Nickel<br>Brushed Bronze | Oil Rubbed<br>Bronze / Std<br>Paint Colors |
|--------------------|---------------|-------------|--|--|
| 24-3/8" - 26-3/16" | 692           | 761         | 796  | 830  |
| 26-3/16" - 28-1/2" | 709           | 780         | 815  | 851  |
| 28-1/2" 30-1/2"    | 720           | 792         | 828  | 864  |
| 76" Height         | Silver / Gold | Pearl White | Satin Chrome<br>Satin Nickel<br>Brushed Bronze | Oil Rubbed<br>Bronze / Std<br>Paint Colors |
| 24-3/8" - 26-3/16" | 748           | 823         | 860  | 898  |
| 26-3/16" - 28-1/2" | 760           | 836         | 874  | 912  |
| 28-1/2" 30-1/2"    | 772           | 849         | 888  | 926  |

\*\* Allow 3 week delivery for painted finishes

- Allowable out of square conditions
- Width up to 1/4" on each wall
- Height up to 1/8" for base

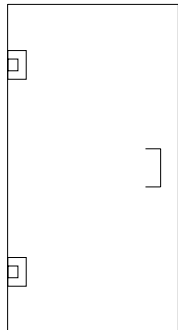

Q-GW-70

## QGW-70 SINGLE DOOR WITHOUT HEADER - BRASS WALL MOUNT HINGES 6" C-PULL HANDLE STANDARD

| 72" Height      | Silver / Gold | Pearl White | Satin Chrome<br>Satin Nickel | Oil Rubbed<br>Bronze |
|-----------------|---------------|-------------|------------------------------|----------------------|
| 24-3/8" - 26"   | 638           | 702         | 734                          | 7665                 |
| 26" - 28-3/4"   | 658           | 724         | 757                          | 790                  |
| 28-3/4" 30-3/8" | 670           | 737         | 771                          | 804                  |
| 76" Height      | Silver / Gold | Pearl White | Satin Chrome<br>Satin Nickel | Oil Rubbed<br>Bronze |
| 24-3/8" - 26"   | 688           | 757         | 791                          | 826                  |
| 26" - 28-3/4"   | 708           | 779         | 814                          | 850                  |
| 28-3/4" 30-3/8" | 720           | 792         | 828                          | 860                  |

• Allowable out of square conditions

- Width up to 3/16" on hinge side up to 1/4" on handle side
- Height up to 3/16" on base

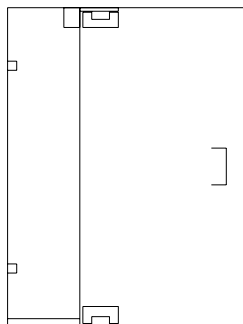

Q-GGP-1627

**NEW**

## QGGP-1627 DOOR AND PANEL - BRASS WALL MOUNT CLIPS, C-PULL

| 72" Height     | Chrome<br>Polished<br>Brass | Polished Nickel<br>Brushed Nickel | 76" Height     | Chrome<br>Polished<br>Brass | Polished Nickel<br>Brushed Nickel |
|----------------|-----------------------------|-----------------------------------|----------------|-----------------------------|-----------------------------------|
| 30 3-16" - 36" | 1584                        | 1684                              | 30 3-16" - 36" | 1638                        | 1738                              |
| 36" - 42"      | 1678                        | 1778                              | 36" - 42"      | 1736                        | 1836                              |
| 42" - 48"      | 1775                        | 1872                              | 42" - 48"      | 1834                        | 1934                              |
| 48" - 54"      | 1866                        | 1966                              | 48" - 54"      | 1932                        | 2032                              |
| 54" - 60"      | 1960                        | 2060                              | 54" - 60"      | 2030                        | 2130                              |

- 1/2" panel • 3/8" doors • AVAILABLE out of square • Width on handle edge 1/4"

**QGAP-1627 DOOR & PANEL - ALUMINUM TOP & BOTTOM PIVOT HINGE SYSTEM ROUND DESIGNER HEADER & BASE - ALUMINUM WALL CHANNEL 6" C-PULL HANDLE STANDARD**

| 72" Height     | Silver / Gold | Pearl White | Satin Chrome<br>Satin Nickel<br>Brushed Bronze | Oil Rubbed<br>Bronze / Std<br>Paint Colors |
|----------------|---------------|-------------|--|--|
| 30-3/16" - 36" | 834           | 918         | 959  | 1001                                       |
| 36" - 42"      | 872           | 959         | 1003   | 1046                                       |
| 42" - 48"      | 908           | 999         | 1044   | 1090                                       |
| 48" - 54"      | 946           | 1041        | 1088   | 1135                                       |
| 54" - 60"      | 984           | 1082        | 1132   | 1181                                       |
| 76" Height     | Silver / Gold | Pearl White | Satin Chrome<br>Satin Nickel<br>Brushed Bronze | Oil Rubbed<br>Bronze / Std<br>Paint Colors |
| 30-3/16" - 36" | 902           | 992         | 1037   | 1082                                       |
| 36" - 42"      | 942           | 1036        | 1083   | 1130                                       |
| 42" - 48"      | 982           | 1080        | 1129   | 1178                                       |
| 48" - 54"      | 1022          | 1124        | 1175   | 1226                                       |
| 54" - 60"      | 1062          | 1168        | 1221   | 1274                                       |

- \*\* Allow 3 week delivery for painted finishes
- Allowable out of square conditions
  - Width up to 1/4" on each wall
  - Height up to 1/8" on base

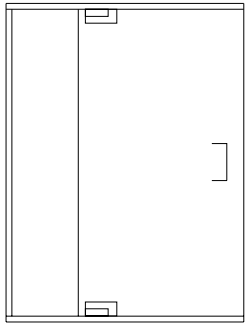

Q-GAP-1627

**QGW-1627 DOOR & PANEL WITHOUT HEADER - BRASS WALL MOUNT HINGE SYSTEM ALUMINUM WALL CHANNEL - 6" C-PULL HANDLE STANDARD**

| 72" Height     | Silver / Gold | Pearl White | Satin Chrome<br>Satin Nickel | Oil Rubbed<br>Bronze |
|----------------|---------------|-------------|------------------------------|----------------------|
| 30-3/16" - 36" | 756           | 832         | 869                          | 907                  |
| 36" - 42"      | 788           | 867         | 906                          | 946                  |
| 42" - 48"      | 822           | 904         | 945                          | 986                  |
| 48" - 54"      | 854           | 939         | 982                          | 1025                 |
| 54" - 60"      | 886           | 975         | 1019                         | 1063                 |
| 76" Height     | Silver / Gold | Pearl White | Satin Chrome<br>Satin Nickel | Oil Rubbed<br>Bronze |
| 30-3/16" - 36" | 842           | 926         | 968                          | 1010                 |
| 36" - 42"      | 878           | 966         | 1010                         | 1054                 |
| 42" - 48"      | 914           | 1005        | 1051                         | 1097                 |
| 48" - 54"      | 948           | 1043        | 1090                         | 1138                 |
| 54" - 60"      | 984           | 1082        | 1132                         | 1181                 |

- Allowable out of square conditions
- Width up to 3/16" on hinge side up to 1/4" on panel side
- Height up to 1/8" on base

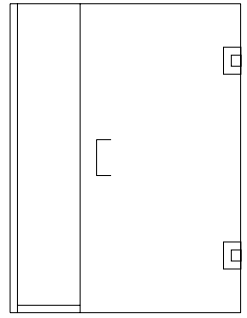

Q-GW-1627

# QUICK SHIP

The Glasstec Quick-Ship program provides fast delivery and discounted prices on the most popular sizes in our Glasstec line. Available in models, sizes and finishes listed below using **90 Degree Stock 3/8" Clear Glass Only...**

ACTUAL MEASUREMENTS AND OUTAGES MUST FALL WITHIN THE SIZE PARAMETERS SHOWN FOR EACH MODEL.

\*\*For Specific Door or Panel Size...Consult Factory for Availability

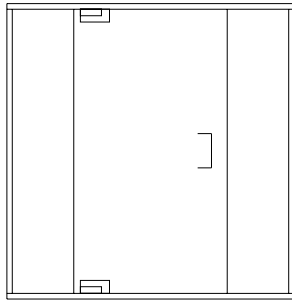

Q-GAP-1628

\*\* Allow 3 week delivery for painted finishes

- Allowable out of square conditions
- Width up to 1/4" on each wall
- Height up to 1/4" on base

## QGAP-1628- DOOR WITH 2 ADJACENT SIDE PANELS - ALUMINUM TOP & BOTTOM PIVOT HINGE SYSTEM ROUND DESIGNER HEADER & BASE 6" C-PULL HANDLE STANDARD

| 72" Height | Silver / Gold | Pearl White | Satin Chrome<br>Satin Nickel<br>Brushed Bronze | Oil Rubbed<br>Bronze / Std<br>Paint Colors |
|------------|---------------|-------------|--|--|
| 48"        | 1232          | 1355        | 1417   | 1478                                       |
| 54"        | 1264          | 1390        | 1454   | 1517                                       |
| 60"        | 1324          | 1456        | 1523   | 1589                                       |
| 66"        | 1356          | 1492        | 1559   | 1627                                       |
| 72"        | 1414          | 1555        | 1626   | 1697                                       |
| 78"        | 1446          | 1591        | 1663   | 1735                                       |
| 84"        | 1506          | 1657        | 1732   | 1807                                       |
| 76" Height | Silver / Gold | Pearl White | Satin Chrome<br>Satin Nickel<br>Brushed Bronze | Oil Rubbed<br>Bronze / Std<br>Paint Colors |
| 48"        | 1266          | 1393        | 1456   | 1519                                       |
| 54"        | 1301          | 1431        | 1496   | 1561                                       |
| 60"        | 1364          | 1500        | 1569   | 1637                                       |
| 66"        | 1398          | 1538        | 1607   | 1678                                       |
| 72"        | 1460          | 1606        | 1679   | 1752                                       |
| 78"        | 1494          | 1643        | 1718   | 1793                                       |
| 84"        | 1558          | 1714        | 1792   | 1870                                       |

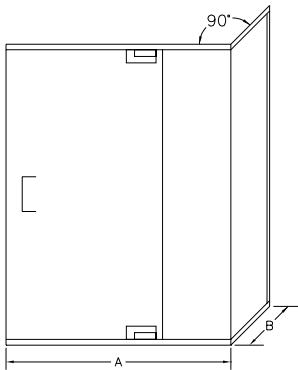

Q-GAP-1631

\*\* Allow 3 week delivery for painted finishes

- Allowable out of square conditions
- Width up to 1/4" front & return
- Height up to 1/8" for base front & return

## QGAP-1631 DOOR & PANEL WITH A FULL HEIGHT 90 DEGREE RETURN PANEL - ALUMINUM TOP & BOTTOM PIVOT HINGE SYSTEM ROUND DESIGNER HEADER & BASE - ALUMINUM WALL CHANNEL - 6" C-PULL HANDLE STANDARD

| 72" Height | Silver / Gold | Pearl White | Satin Chrome<br>Satin Nickel<br>Brushed Bronze | Oil Rubbed<br>Bronze / Std<br>Paint Colors |
|------------|---------------|-------------|--|--|
| 66"        | 1610          | 1771        | 1852   | 1932                                       |
| 72"        | 1710          | 1881        | 1967   | 2052                                       |
| 78"        | 1810          | 1991        | 2082   | 2172                                       |
| 84"        | 1910          | 2101        | 2197   | 2292                                       |
| 90"        | 2010          | 2211        | 2312   | 2412                                       |
| 96"        | 2110          | 2321        | 2427   | 2532                                       |
| 102"       | 2210          | 2431        | 2542   | 2652                                       |
| 76" Height | Silver / Gold | Pearl White | Satin Chrome<br>Satin Nickel<br>Brushed Bronze | Oil Rubbed<br>Bronze / Std<br>Paint Colors |
| 66"        | 1714          | 1885        | 1971   | 2057                                       |
| 72"        | 1822          | 2004        | 2095   | 2186                                       |
| 78"        | 1930          | 2123        | 2220   | 2316                                       |
| 84"        | 2038          | 2242        | 2344   | 2446                                       |
| 90"        | 2146          | 2361        | 2468   | 2575                                       |
| 96"        | 2254          | 2479        | 2592   | 2705                                       |
| 102"       | 2362          | 2598        | 2716   | 2834                                       |

**QGW-1631 DOOR & PANEL WITH A FULL HEIGHT 90 DEGREE FULL PANEL NO HEADER BRASS WALL MOUNT HINGE SYSTEM - ALUMINUM WALL CHANNEL 6" C-PULL STANDARD**

| 72" Height | Silver / Gold | Pearl White | Satin Chrome<br>Satin Nickel | Oil Rubbed<br>Bronze                       |
|------------|---------------|-------------|------------------------------|--|
| 66"        | 1524          | 1676        | 1753                         | 1829                                       |
| 72"        | 1626          | 1789        | 1870                         | 1951                                       |
| 78"        | 1728          | 1901        | 1987                         | 2074                                       |
| 84"        | 1830          | 2013        | 2105                         | 2196                                       |
| 90"        | 1932          | 2125        | 2222                         | 2318                                       |
| 96"        | 2034          | 2237        | 2339                         | 2441                                       |
| 102"       | 2136          | 2350        | 2456                         | 2563                                       |
| 76" Height | Silver / Gold | Pearl White | Satin Chrome<br>Satin Nickel | Oil Rubbed<br>Bronze / Std<br>Paint Colors |
| 66"        | 1620          | 1782        | 1863                         | 1944                                       |
| 72"        | 1732          | 1905        | 1992                         | 2078                                       |
| 78"        | 1844          | 2028        | 2121                         | 2213                                       |
| 84"        | 1956          | 2152        | 2249                         | 2347                                       |
| 90"        | 2068          | 2275        | 2378                         | 2482                                       |
| 96"        | 2180          | 2398        | 2507                         | 2616                                       |
| 102"       | 2292          | 2521        | 2636                         | 2750                                       |

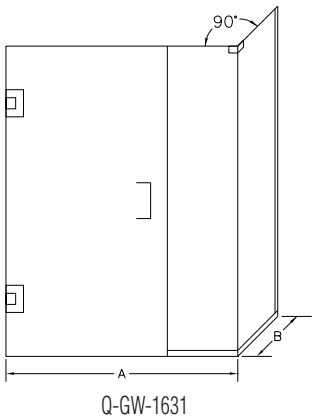

- Allowable out of square conditions
- Width up to 3/16" hinge side
- Height up to 1/8" for front & 1/8" for return

**QGAP-1632-ALUMINUM DOOR WITH 2 ADJACENT SIDE PANELS & FULL HEIGHT 90 DEGREE RETURN PANEL TOP & BOTTOM ALUMINUM PIVOT HINGE SYSTEM - ROUND HEADER & BASE -ALUMINUM WALL CHANNEL 6 C-PULL HANDLE STANDARD**

| 72" Height | Silver / Gold | Pearl White | Satin Chrome<br>Satin Nickel<br>Brushed Bronze | Oil Rubbed<br>Bronze / Std<br>Paint Colors |
|------------|---------------|-------------|--|--|
| 72"        | 1868          | 2055        | 2148   | 2242                                       |
| 78"        | 1982          | 2180        | 2279   | 2378                                       |
| 84"        | 2096          | 2306        | 2410   | 2515                                       |
| 90"        | 2164          | 2380        | 2489   | 2597                                       |
| 96"        | 2222          | 2444        | 2555   | 2666                                       |
| 102"       | 2280          | 2508        | 2622   | 2736                                       |
| 108"       | 2338          | 2572        | 2689   | 2806                                       |
| 76" Height | Silver / Gold | Pearl White | Satin Chrome<br>Satin Nickel<br>Brushed Bronze | Oil Rubbed<br>Bronze / Std<br>Paint Colors |
| 72"        | 1954          | 2150        | 2247   | 2345                                       |
| 78"        | 2074          | 2281        | 2385   | 2489                                       |
| 84"        | 2194          | 2413        | 2523   | 2633                                       |
| 90"        | 2262          | 2488        | 2601   | 2715                                       |
| 96"        | 2330          | 2563        | 2680   | 2796                                       |
| 102"       | 2432          | 2675        | 2797   | 2918                                       |
| 108"       | 2524          | 2776        | 2903   | 3029                                       |

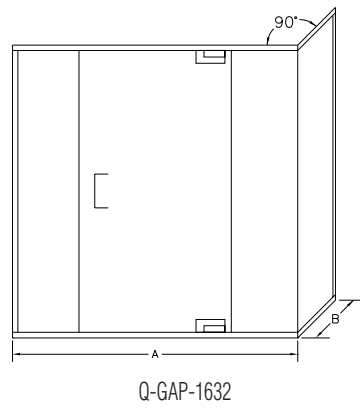

- \*\* Allow 3 week delivery for painted finishes
- Allowable out of square conditions
- Width up to 1/4" front & return
- Height up to 1/4" front & 1/8" on return
- Height up to 1/8" on base

# ALUMINUM PIVOT HINGE DOORS

## Standard Features ON GAP MODELS

- Aluminum top and bottom pivot hinges
- Aluminum round designer header and base where indicated (not required on GAPW models)
- Frameless 3/8" clear glass with 90 degree edges
- Standard finishes: silver anodized aluminum; gold anodized aluminum
- Mounts to header and base or direct mount
- 6" C-pull handle



GAP Pivot Hinge Mounts to Header or Soffit

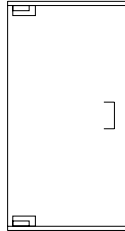

GAP-70  
Single Door with Header

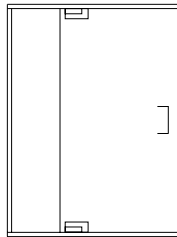

GAP-1627  
Door & Panel, with Header

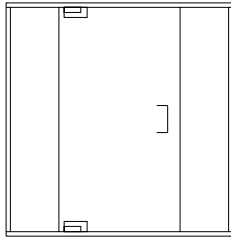

GAP-1628  
Panel, Door, Panel with Header

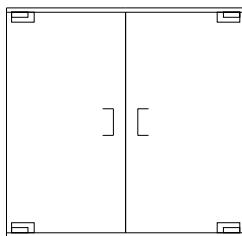

GAP-1629  
French Doors with Header

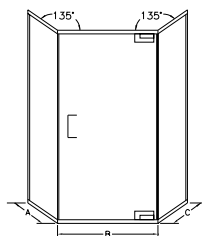

GAP-1669  
Neo-Angle with Header

### GAP-70

|            |      |      |      |      |      |
|------------|------|------|------|------|------|
| 84" Height | 1171 | 1199 | 1227 | 1256 | 1284 |
| 80" Height | 1152 | 1179 | 1206 | 1233 | 1261 |
| 76" Height | 1133 | 1159 | 1185 | 1211 | 1237 |
| 72" Height | 1086 | 1111 | 1136 | 1160 | 1185 |
| WIDTH      | 24"  | 26"  | 28"  | 30"  | 32"  |

### GAP-1627

|            |      |      |      |      |      |      |      |
|------------|------|------|------|------|------|------|------|
| 84" Height | 1549 | 1637 | 1725 | 1813 | 1900 | 2003 | 2090 |
| 80" Height | 1513 | 1598 | 1682 | 1766 | 1850 | 1948 | 2033 |
| 76" Height | 1456 | 1537 | 1617 | 1697 | 1778 | 1873 | 1953 |
| 72" Height | 1400 | 1476 | 1553 | 1630 | 1707 | 1798 | 1875 |
| WIDTH      | 36"  | 42"  | 48"  | 54"  | 60"  | 66"  | 72"  |

### GAP-1628

|            |      |      |      |      |      |      |      |
|------------|------|------|------|------|------|------|------|
| 84" Height | 1962 | 2024 | 2142 | 2204 | 2322 | 2384 | 2502 |
| 80" Height | 1892 | 1951 | 2065 | 2124 | 2237 | 2297 | 2410 |
| 76" Height | 1837 | 1894 | 2002 | 2059 | 2167 | 2224 | 2332 |
| 72" Height | 1795 | 1850 | 1953 | 2008 | 2111 | 2165 | 2269 |
| WIDTH      | 48"  | 54"  | 60"  | 66"  | 72"  | 78"  | 84"  |

### GAP-1629

|            |      |      |      |      |      |      |
|------------|------|------|------|------|------|------|
| 84" Height | 1993 | 2048 | 2156 | 2210 | 2318 | 2373 |
| 80" Height | 1961 | 2013 | 2116 | 2168 | 2271 | 2323 |
| 76" Height | 1907 | 1957 | 2055 | 2105 | 2203 | 2252 |
| 72" Height | 1854 | 1901 | 1994 | 2042 | 2135 | 2182 |
| WIDTH      | 30"  | 36"  | 42"  | 48"  | 54"  | 60"  |

### GAP-1669 - 90 DEGREE DOOR

|             |      |      |      |      |      |      |      |
|-------------|------|------|------|------|------|------|------|
| 84" Height  | 2244 | 2334 | 2424 | 2514 | 2603 | 2689 | 2779 |
| 80" Height  | 2186 | 2272 | 2359 | 2445 | 2531 | 2613 | 2699 |
| 76" Height  | 2129 | 2211 | 2294 | 2376 | 2459 | 2537 | 2620 |
| 72" Height  | 2029 | 2108 | 2187 | 2265 | 2344 | 2419 | 2498 |
| WIDTH A+B+C | 60"  | 66"  | 72"  | 78"  | 84"  | 90"  | 96"  |



## AVAILABLE UPGRADES FOR GAP MODELS

Finish options see page 29

Glass options see page 28

Accessory options see pages 29-30

Vents and Transoms see pages 26-27

### GAP-1669 & GAP-1669-B

|             |      |      |      |      |      |      |      |
|-------------|------|------|------|------|------|------|------|
| 84" Height  | 2396 | 2486 | 2576 | 2666 | 2756 | 2841 | 2931 |
| 80" Height  | 2331 | 2418 | 2504 | 2590 | 2677 | 2758 | 2844 |
| 76" Height  | 2266 | 2349 | 2432 | 2514 | 2597 | 2675 | 2757 |
| 72" Height  | 2159 | 2238 | 2317 | 2396 | 2475 | 2549 | 2628 |
| WIDTH A+B+C | 60"  | 66"  | 72"  | 78"  | 84"  | 90"  | 96"  |

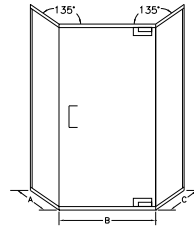

GAP-1669  
Neo-Angle with Header

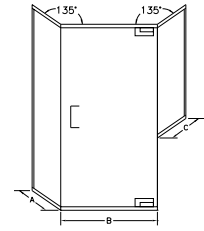

GAP-1669-B  
Neo-Angle with Buttress Panel & Header

### GAP-1669-2/3

|            |      |      |      |      |      |      |
|------------|------|------|------|------|------|------|
| 84" Height | 1728 | 1818 | 1908 | 1998 | 2083 | 2173 |
| 80" Height | 1658 | 1744 | 1830 | 1917 | 1999 | 2084 |
| 76" Height | 1602 | 1685 | 1767 | 1850 | 1928 | 2010 |
| 72" Height | 1560 | 1639 | 1718 | 1797 | 1871 | 1950 |
| WIDTH A+B  | 36"  | 42"  | 48"  | 54"  | 60"  | 66"  |

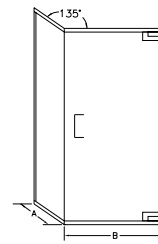

GAP-1669 2/3  
Two-Thirds Neo-Angle with Header

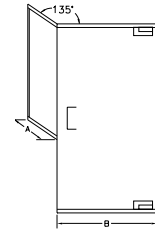

GAP-1669 2/3-B  
Two-Thirds Neo-Angle with  
Buttress Return and Header

### GAP-1631 & GAP-1631-B

|            |      |      |      |      |      |      |      |
|------------|------|------|------|------|------|------|------|
| 84" Height | 2270 | 2361 | 2451 | 2541 | 2631 | 2722 | 2813 |
| 80" Height | 2218 | 2305 | 2391 | 2478 | 2564 | 2651 | 2738 |
| 76" Height | 2166 | 2249 | 2232 | 2414 | 2497 | 2580 | 2663 |
| 72" Height | 2072 | 2151 | 2230 | 2309 | 2389 | 2468 | 2547 |
| WIDTH A+B  | 66"  | 72"  | 78"  | 84"  | 90"  | 96"  | 102" |

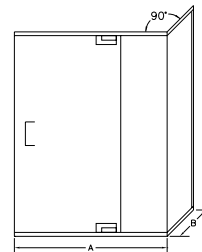

GAP-1631  
Corner Enclosure with Header

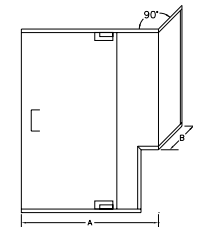

GAP-1631-NB  
Corner Enclosure with Buttress  
Return and Header

### GAP-1632 & GAP-1632-B

|            |      |      |      |      |      |      |      |
|------------|------|------|------|------|------|------|------|
| 84" Height | 2382 | 2472 | 2534 | 2624 | 2714 | 2831 | 2921 |
| 80" Height | 2323 | 2409 | 2469 | 2556 | 2642 | 2754 | 2841 |
| 76" Height | 2264 | 2347 | 2405 | 2487 | 2570 | 2677 | 2760 |
| 72" Height | 2205 | 2284 | 2340 | 2419 | 2498 | 2600 | 2679 |
| WIDTH A+B  | 72"  | 78"  | 84"  | 90"  | 96"  | 102" | 108" |

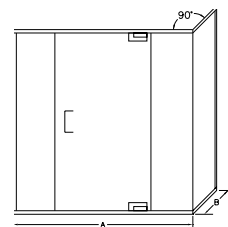

GAP-1632  
Panel, Door, Panel Corner  
Enclosure with Header

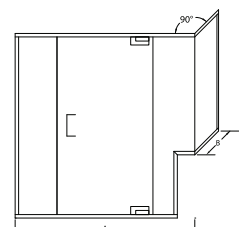

GAP-1632-NB  
Panel, Door, Panel Corner  
Enclosure with  
Buttress Return and Header

Notched panels, add \$250 for polished edge to prices listed above  
\$175 for swiped edge

# ALUMINUM PIVOT HINGE DOORS

## Standard Features ON GAPW MODELS

- Aluminum wall mounted top pivot hinges
- Frameless 3/8" clear glass with 90 degree edges
- Standard finishes: Silver Anodized Aluminum; Gold Anodized Aluminum
- 6" C-pull handle

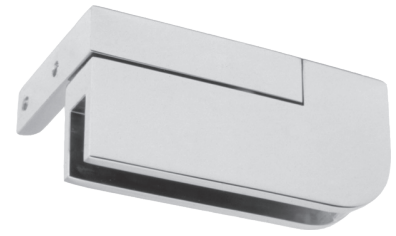

GAPW Pivot Hinge

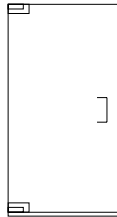

GAPW-70  
Single Door without Header

| GAPW-70    |      |      |      |      |      |
|------------|------|------|------|------|------|
| 84" Height | 1125 | 1153 | 1180 | 1207 | 1234 |
| 80" Height | 1107 | 1133 | 1158 | 1184 | 1210 |
| 76" Height | 1088 | 1112 | 1137 | 1162 | 1187 |
| 72" Height | 1041 | 1064 | 1088 | 1112 | 1135 |
| WIDTH      | 24"  | 26"  | 28"  | 30"  | 32"  |

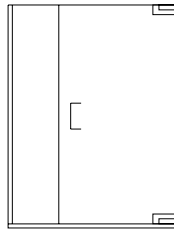

GAPW-1627  
Door & Panel without Header

| GAPW-1627  |      |      |      |      |      |      |      |
|------------|------|------|------|------|------|------|------|
| 84" Height | 1432 | 1516 | 1600 | 1684 | 1902 | 2019 | 2122 |
| 80" Height | 1396 | 1477 | 1557 | 1637 | 1845 | 1958 | 2056 |
| 76" Height | 1339 | 1416 | 1492 | 1569 | 1767 | 1875 | 1969 |
| 72" Height | 1282 | 1355 | 1428 | 1501 | 1690 | 1793 | 1883 |
| WIDTH      | 36"  | 42"  | 48"  | 54"  | 60"  | 66"  | 72"  |

36"-54" 3/8" Door - 3/8" Panel  
60"+ Over 3/8" Door - 1/2" Panel

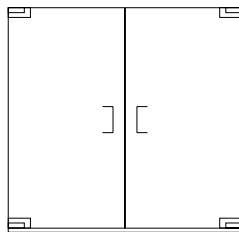

GAPW-1629  
French Doors without Header

| GAPW-1629  |      |      |      |      |      |      |  |
|------------|------|------|------|------|------|------|--|
| 84" Height | 1818 | 1872 | 1980 | 2035 | 2143 | 2197 |  |
| 80" Height | 1785 | 1838 | 1940 | 1993 | 2096 | 2148 |  |
| 76" Height | 1731 | 1781 | 1879 | 1929 | 2027 | 2077 |  |
| 72" Height | 1678 | 1726 | 1819 | 1866 | 1959 | 2007 |  |
| WIDTH      | 30"  | 36"  | 42"  | 48"  | 54"  | 60"  |  |

## AVAILABLE UPGRADES FOR GAPW MODELS

Finish options see page 29

Glass options see page 28

Accessory options see pages 29-30

Vents and Transoms see pages 26-27

### GAPW-1669-2/3

|            |      |      |      |      |      |      |
|------------|------|------|------|------|------|------|
| 84" Height | 1592 | 1678 | 1764 | 1970 | 2047 | 2153 |
| 80" Height | 1527 | 1610 | 1692 | 1889 | 1962 | 2064 |
| 76" Height | 1478 | 1556 | 1635 | 1823 | 1892 | 1989 |
| 72" Height | 1442 | 1517 | 1592 | 1771 | 1837 | 1929 |
| WIDTH A+B  | 36"  | 42"  | 48"  | 54"  | 60"  | 66"  |

36"-48" 3/8" Door - 3/8" Panel

54"-66" 3/8" Door - 1/2" Panel

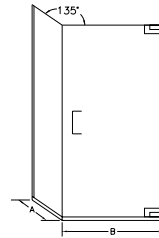

GAPW-1669 2/3  
Two-Thirds Neo-Angle

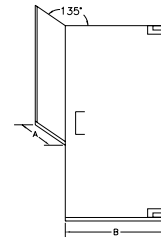

GAPW-1669 2/3-B  
Two-Thirds Neo-Angle with  
Buttruss Return

### GAPW-1631 & GAPW-1631-B

|            |      |      |      |      |      |      |      |
|------------|------|------|------|------|------|------|------|
| 84" Height | 2184 | 2270 | 2357 | 2443 | 2832 | 2940 | 3045 |
| 80" Height | 2132 | 2214 | 2297 | 2380 | 2753 | 2880 | 2957 |
| 76" Height | 2079 | 2158 | 2237 | 2316 | 2674 | 2771 | 2868 |
| 72" Height | 1985 | 2061 | 2136 | 2211 | 2553 | 2646 | 2739 |
| WIDTH A+B  | 66"  | 72"  | 78"  | 84"  | 90"  | 96"  | 102" |

\*Additional width may require header for GAPW units

36"-48" 3/8" Door - 3/8" Panel

54"-66" 3/8" Door - 1/2" Panel

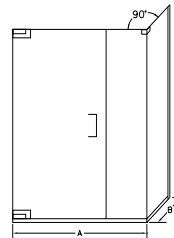

GAPW-1631  
Corner Enclosure without  
Header, with top mount  
corner clip

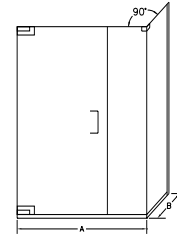

GAPW-1631-NB  
Corner Enclosure with Buttruss Return,  
without Header, with top mount corner clip

Notched panels, add \$250 for polished edge to prices listed above  
\$175 for swiped edge

# BRASS PIVOT HINGE DOORS

## Standard Features on GP Models

- Solid Brass top & bottom pivot hinge system
- Solid Brass round designer header and base where indicated (not required on GPW models)
- Frameless 3/8" Clear glass with 90 degree edges
- Standard Finishes:
  - Polished Chrome
  - Polished Nickel
  - Satin Chrome
  - Satin Nickel
- Mounts to header and base or direct mount
- 6" C-Pull handle

## AVAILABLE UPGRADES FOR GP MODELS

Finish options see page 29

Glass options see page 28

Accessory options see pages 29-30

Vents and Transoms see pages 26-27

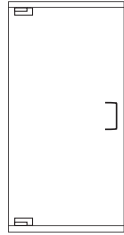

GP-70  
Single Door with Header

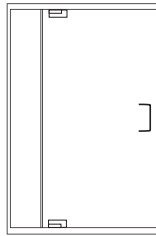

GP-1627  
Door & Panel, with Header

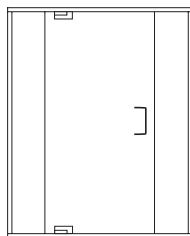

GP-1628  
Panel, Door, Panel with Header

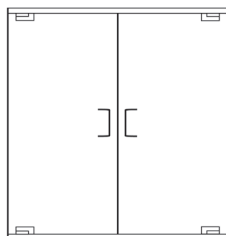

GP-1629  
French Doors with Header

### GP-70

|            |      |      |      |      |      |      |
|------------|------|------|------|------|------|------|
| 92" Height | 1745 | 1794 | 1843 | 1903 | 1952 | 2001 |
| 88" Height | 1724 | 1772 | 1820 | 1879 | 1927 | 1975 |
| 84" Height | 1704 | 1751 | 1798 | 1856 | 1902 | 1949 |
| 80" Height | 1684 | 1729 | 1775 | 1832 | 1877 | 1923 |
| 76" Height | 1652 | 1696 | 1741 | 1796 | 1841 | 1885 |
| 72" Height | 1631 | 1675 | 1718 | 1772 | 1816 | 1859 |
| WIDTH      | 24"  | 26"  | 28"  | 30"  | 32"  | 34"  |

### GP-1627

|            |      |      |      |      |      |      |      |
|------------|------|------|------|------|------|------|------|
| 92" Height | 2673 | 2826 | 3039 | 3222 | 3405 | 3602 | 3785 |
| 88" Height | 2626 | 2805 | 2985 | 3164 | 3344 | 3537 | 3717 |
| 84" Height | 2579 | 2755 | 2931 | 3107 | 3283 | 3473 | 3649 |
| 80" Height | 2526 | 2698 | 2871 | 3043 | 3216 | 3402 | 3574 |
| 76" Height | 2440 | 2609 | 2778 | 2947 | 3116 | 3298 | 3469 |
| 72" Height | 2357 | 2523 | 2683 | 2854 | 3019 | 3199 | 3364 |
| WIDTH      | 36"  | 42"  | 48"  | 54"  | 60"  | 66"  | 72"  |

\*Additional width may require header for GPW units

### GP-1628

|            |      |      |      |      |      |      |      |
|------------|------|------|------|------|------|------|------|
| 92" Height | 3930 | 4082 | 4291 | 4457 | 4666 | 4817 | 5027 |
| 88" Height | 3841 | 3990 | 4194 | 4358 | 4562 | 4711 | 4915 |
| 84" Height | 3752 | 3899 | 4098 | 4253 | 4458 | 4605 | 4804 |
| 80" Height | 3663 | 3807 | 4001 | 4160 | 4354 | 4498 | 4693 |
| 76" Height | 3532 | 3674 | 3864 | 4020 | 4209 | 4351 | 4541 |
| 72" Height | 3402 | 3541 | 3726 | 3879 | 4064 | 4203 | 4388 |
| WIDTH      | 48"  | 54"  | 60"  | 66"  | 72"  | 78"  | 84"  |

### GP-1629

|            |      |      |      |      |      |      |
|------------|------|------|------|------|------|------|
| 92" Height | 2834 | 2958 | 3133 | 3256 | 3432 | 3555 |
| 88" Height | 2807 | 2928 | 3099 | 3220 | 3391 | 3512 |
| 84" Height | 2780 | 2899 | 3065 | 3184 | 3350 | 3469 |
| 80" Height | 2753 | 2870 | 3031 | 3148 | 3309 | 3425 |
| 76" Height | 2715 | 2829 | 2986 | 3099 | 3256 | 3370 |
| 72" Height | 2688 | 2799 | 2952 | 3063 | 3215 | 3327 |
| WIDTH      | 30"  | 36"  | 42"  | 48"  | 54"  | 60"  |

\* GP only. Not available on GPW. - weight restrictions

### GP-1669 90 DEGREE DOOR

|             |      |      |      |      |      |      |      |
|-------------|------|------|------|------|------|------|------|
| 92" Height  | 4462 | 4638 | 4870 | 5047 | 5279 | 5434 | 5610 |
| 88" Height  | 4370 | 4544 | 4772 | 4945 | 5173 | 5324 | 5498 |
| 84" Height  | 4279 | 4450 | 4673 | 4844 | 5067 | 5214 | 5385 |
| 80" Height  | 4158 | 4327 | 4545 | 4714 | 4932 | 5075 | 5244 |
| 76" Height  | 4053 | 4220 | 4432 | 4599 | 4812 | 4952 | 5118 |
| 72" Height  | 3962 | 4126 | 4334 | 4498 | 4706 | 4842 | 5006 |
| WIDTH A+B+C | 60"  | 66"  | 72"  | 78"  | 84"  | 90"  | 96"  |

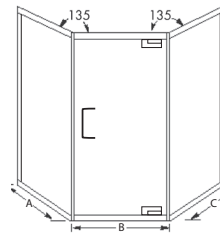

GP-1669  
Neo-Angle with Header

### GP-1669 & GP-1669-B

|             |      |      |      |      |      |      |      |
|-------------|------|------|------|------|------|------|------|
| 92" Height  | 4629 | 4806 | 5038 | 5214 | 5447 | 5601 | 5778 |
| 88" Height  | 4530 | 4704 | 4932 | 5106 | 5333 | 5484 | 5658 |
| 84" Height  | 4432 | 4603 | 4826 | 4997 | 5220 | 5367 | 5538 |
| 80" Height  | 4304 | 4473 | 4691 | 4859 | 5077 | 5221 | 5390 |
| 76" Height  | 4191 | 4357 | 4570 | 4737 | 4950 | 5090 | 5256 |
| 72" Height  | 4092 | 4256 | 4464 | 4628 | 4836 | 4972 | 5136 |
| WIDTH A+B+C | 60"  | 66"  | 72"  | 78"  | 84"  | 90"  | 96"  |

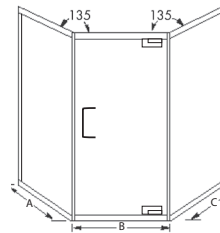

GP-1669  
Neo-Angle with Header

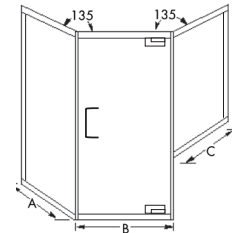

GP-1669-B  
Neo-Angle with Buttress  
Panel and Header

### GP-1669-2/3

|            |      |      |      |      |      |      |
|------------|------|------|------|------|------|------|
| 92" Height | 3062 | 3257 | 3428 | 3624 | 3795 | 3991 |
| 88" Height | 3006 | 3198 | 3366 | 3558 | 3725 | 3917 |
| 84" Height | 2951 | 3139 | 3303 | 3491 | 3655 | 3843 |
| 80" Height | 2867 | 3051 | 3211 | 3396 | 3556 | 3741 |
| 76" Height | 2797 | 2978 | 3135 | 3316 | 3472 | 3653 |
| 72" Height | 2742 | 2919 | 3072 | 3249 | 3402 | 3579 |
| WIDTH A+B  | 36"  | 42"  | 48"  | 54"  | 60"  | 66"  |

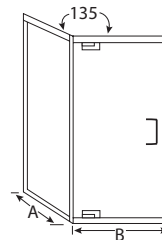

GP-1669 2/3  
Two-Thirds Neo-Angle with Header

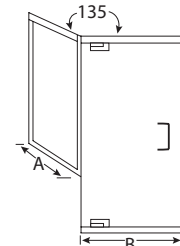

GP-1669 2/3-B  
Two-Thirds Neo-Angle with  
Buttress Return and Header

### GP-1631 & GP-1631-B

|            |      |      |      |      |      |      |      |
|------------|------|------|------|------|------|------|------|
| 92" Height | 4295 | 4487 | 4679 | 4870 | 4983 | 5175 | 5367 |
| 88" Height | 4211 | 4399 | 4587 | 4775 | 4885 | 5073 | 5261 |
| 84" Height | 4126 | 4312 | 4496 | 4680 | 4786 | 4970 | 5155 |
| 80" Height | 4036 | 4217 | 4398 | 4578 | 4680 | 4861 | 5042 |
| 76" Height | 3897 | 4073 | 4251 | 4428 | 4526 | 4703 | 4880 |
| 72" Height | 3757 | 3930 | 4104 | 4277 | 4371 | 4545 | 4718 |
| WIDTH A+B  | 66"  | 72"  | 78"  | 84"  | 90"  | 96"  | 102" |

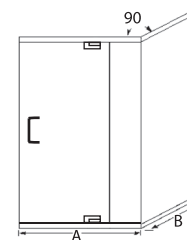

GP-1631  
Corner Enclosure with Header

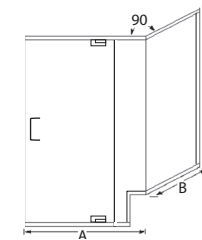

GP-1631-NB  
Corner Enclosure with  
Buttress Return and Header

### GP-1632 & GP-1632-B

|            |      |      |      |      |      |      |      |
|------------|------|------|------|------|------|------|------|
| 92" Height | 4524 | 4700 | 4846 | 5022 | 5227 | 5403 | 5563 |
| 88" Height | 4432 | 4605 | 4748 | 4921 | 5120 | 5293 | 5451 |
| 84" Height | 4340 | 4509 | 4650 | 4819 | 5014 | 5183 | 5338 |
| 80" Height | 4241 | 4407 | 4545 | 4710 | 4900 | 5066 | 5218 |
| 76" Height | 4108 | 4270 | 4406 | 4568 | 4753 | 4914 | 5065 |
| 72" Height | 3942 | 4100 | 4234 | 4392 | 4572 | 4730 | 4878 |
| WIDTH A+B  | 72"  | 78"  | 84"  | 90"  | 96"  | 102" | 108" |

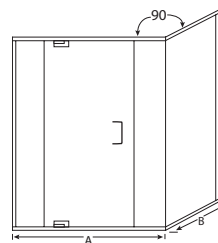

GP-1632  
Panel, Door, Panel Corner  
Enclosure with Header

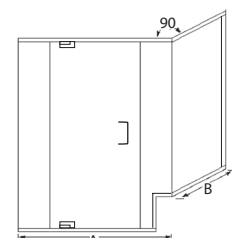

GP-1632-NB  
Panel, Door, Panel Corner  
Enclosure with Buttress Return and Header

Notched panels, add \$250 for polished edge to prices listed above  
\$175 for swiped edge

# BRASS PIVOT HINGE DOORS

## Standard Features on GPW Models

- Solid Brass pivot hinges
- No Header
- Base only where indicated
- Frameless 3/8" Clear glass with 90 degree edges
- Standard Finishes: • Polished Chrome • Satin Chrome  
• Polished Nickel • Satin Nickel
- 6" C-Pull handle

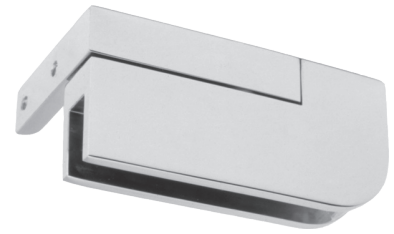

GPW Pivot Hinge Mounts to Wall

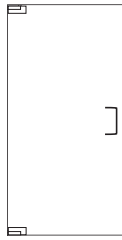

GPW-70  
Single Door without Header

| GPW-70     |      |      |      |      |      |      |
|------------|------|------|------|------|------|------|
| 92" Height | 1531 | 1569 | 1607 | 1656 | 1694 | 1733 |
| 88" Height | 1514 | 1551 | 1588 | 1637 | 1673 | 1710 |
| 84" Height | 1498 | 1534 | 1570 | 1617 | 1652 | 1688 |
| 80" Height | 1482 | 1517 | 1551 | 1597 | 1631 | 1666 |
| 76" Height | 1454 | 1487 | 1520 | 1565 | 1598 | 1631 |
| 72" Height | 1437 | 1470 | 1501 | 1545 | 1577 | 1609 |
| Width      | 24"  | 26"  | 28"  | 30"  | 32"  | 34"  |

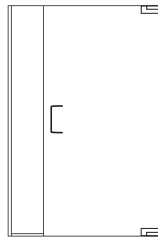

GPW-1627  
Door & Panel without Header

| GPW-1627   |      |      |      |      |      |      |      |
|------------|------|------|------|------|------|------|------|
| 92" Height | 2456 | 2613 | 2771 | 2928 | 3085 | 3257 | 3414 |
| 88" Height | 2412 | 2566 | 2719 | 2873 | 3027 | 3195 | 3349 |
| 84" Height | 2368 | 2518 | 2668 | 2818 | 2968 | 3133 | 3283 |
| 80" Height | 2317 | 2464 | 2610 | 2756 | 2903 | 3063 | 3210 |
| 76" Height | 2232 | 2375 | 2518 | 2660 | 2803 | 2960 | 3103 |
| 72" Height | 2151 | 2290 | 2429 | 2568 | 2707 | 2861 | 3000 |
| Width      | 36"  | 42"  | 48"  | 54"  | 60"  | 66"  | 72"  |

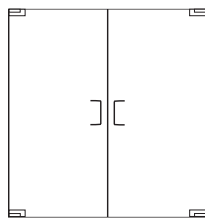

GPW-1629  
French Doors without Header

| GPW-1629    |      |      |      |      |      |      |
|-------------|------|------|------|------|------|------|
| 92" Height  | 2742 | 2831 | 2974 | 3063 | 3207 | 3296 |
| 88" Height  | 2713 | 2800 | 2939 | 3025 | 3164 | 3251 |
| 84" Height  | 2685 | 2769 | 2903 | 2987 | 3121 | 3205 |
| 80" Height  | 2657 | 2738 | 2868 | 2949 | 3078 | 3160 |
| 76" Height  | 2616 | 2695 | 2820 | 2899 | 3023 | 3102 |
| 72" Height  | 2588 | 2665 | 2784 | 2861 | 2980 | 3057 |
| Width A + B | 30"  | 36"  | 42"  | 48"  | 54"  | 60"  |

**AVAILABLE UPGRADES FOR GPW MODELS**

Finish options see page 29  
 Glass options see page 28  
 Accessory options see pages 29-30  
 Vents and Transoms see pages 26-27

| GPW-1669-2/3 |      |      |      |      |      |      |  |
|--------------|------|------|------|------|------|------|--|
| 92" Height   | 2671 | 2826 | 2957 | 3113 | 3243 | 3399 |  |
| 88" Height   | 2620 | 2772 | 2899 | 3051 | 3178 | 3330 |  |
| 84" Height   | 2570 | 2718 | 2842 | 2990 | 3113 | 3262 |  |
| 80" Height   | 2491 | 2636 | 2755 | 2900 | 3020 | 3164 |  |
| 76" Height   | 2427 | 2568 | 2684 | 2825 | 2941 | 3082 |  |
| 72" Height   | 2377 | 2514 | 2626 | 2764 | 2876 | 3013 |  |
| Width        | 36"  | 42"  | 48"  | 54"  | 60"  | 66"  |  |

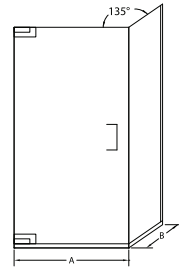

GPW-1669 2/3  
Two-Thirds Neo-Angle

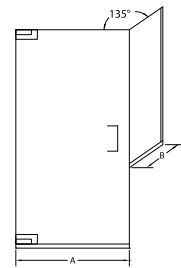

GPW-1669 2/3-B  
Two-Thirds Neo-Angle with  
Buttress Return

| GPW-1631 & GPW-1631-B |      |      |      |      |      |      |      |
|-----------------------|------|------|------|------|------|------|------|
| 92" Height            | 3913 | 4071 | 4228 | 4385 | 4464 | 4621 | 4778 |
| 88" Height            | 3829 | 3983 | 4137 | 4290 | 4365 | 4519 | 4672 |
| 84" Height            | 3745 | 3895 | 4045 | 4195 | 4266 | 4416 | 4566 |
| 80" Height            | 3654 | 3800 | 3947 | 4093 | 4161 | 4307 | 4453 |
| 76" Height            | 3515 | 3657 | 3821 | 3943 | 4006 | 4149 | 4292 |
| 72" Height            | 3375 | 3514 | 3653 | 3792 | 3852 | 3991 | 4130 |
| Width A + B           | 66"  | 72"  | 78"  | 84"  | 90"  | 96"  | 102" |

\*Additional width may require header for GPW units

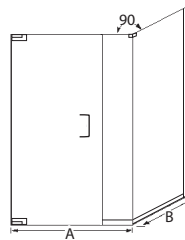

GPW-1631  
Corner Enclosure without Header,  
with Top Mount Corner Clip

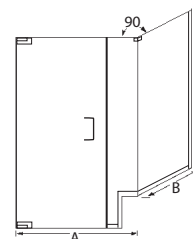

GPW-1631-NB  
Corner Enclosure with Buttress  
Return, without Header, with Top  
Mount Corner Clip

**BRASS PIVOT DOOR HINGES**

Notched panels, add \$250 for polished edge to prices listed above  
 \$175 for swiped edge

# BRASS WALL MOUNT HINGE DOORS

## Standard Features on GW Models

- Solid Brass wall mounted hinges - dual acting
- Extruded Aluminum or Brass wall channel for stationary panel(s) where indicated
- Frameless 3/8" Clear glass with 90 degree edges
- Standard 24" door width on Door/Panel and Corner Enclosure models
- Aluminum Standard Finishes: Silver Anodized Aluminum; Gold Anodized Aluminum
- Solid Brass Standard Finishes: Polished Chrome; Satin Chrome; Polished Nickel; Satin Nickel
- 6" C-Pull handle

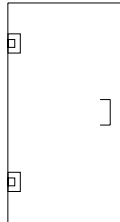

GW-70  
Single Door

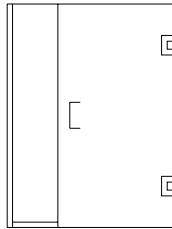

GW-1627  
Door & Panel with Wall Channel

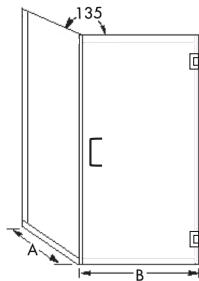

GW-1669-2/3  
Two-Thirds Neo-Angle with Wall Channel

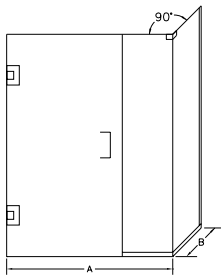

GW-1631  
Corner Enclosure with Wall  
Channel and Corner Clip

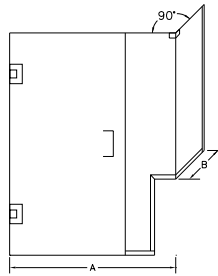

GW-1631-NB  
Corner Enclosure with  
Buttress Return, Wall  
Channel & Corner Clip

### GW-70

|            |      |      |      |       |       |
|------------|------|------|------|-------|-------|
| 84" Height | 1084 | 1111 | 1305 | *1332 | *1359 |
| 80" Height | 1051 | 1077 | 1103 | *1295 | *1321 |
| 76" Height | 1042 | 1057 | 1082 | *1273 | *1298 |
| 72" Height | 1000 | 1023 | 1046 | *1237 | *1260 |
| WIDTH      | 24"  | 26"  | 28"  | 30"   | 32"   |

### GW-1627 • ALUMINUM WALL CHANNEL

|            |      |      |      |      |      |
|------------|------|------|------|------|------|
| 84" Height | 1362 | 1445 | 1528 | 1611 | 1694 |
| 80" Height | 1327 | 1406 | 1485 | 1564 | 1643 |
| 76" Height | 1269 | 1345 | 1420 | 1496 | 1571 |
| 72" Height | 1213 | 1284 | 1356 | 1428 | 1500 |
| WIDTH      | 36"  | 42"  | 48"  | 54"  | 60"  |

### GW-1669-2/3 & GW-1669-2/3-B ALUMINUM WALL CHANNEL

|            |      |      |      |      |      |      |
|------------|------|------|------|------|------|------|
| 92" Height | 1849 | 1940 | 2031 | 2286 | 2377 | 2468 |
| 88" Height | 1807 | 1894 | 1982 | 2233 | 2320 | 2407 |
| 84" Height | 1764 | 1848 | 1932 | 2179 | 2263 | 2347 |
| 80" Height | 1694 | 1774 | 1854 | 1932 | 2012 | 2092 |
| 76" Height | 1637 | 1714 | 1790 | 1865 | 1941 | 2018 |
| 72" Height | 1595 | 1668 | 1741 | 1812 | 1885 | 1957 |
| WIDTH A+B  | 42"  | 48"  | 54"  | 60"  | 66"  | 72"  |

### GW-1631 & GW1631-B ALUMINUM WALL CHANNEL

|            |      |      |      |      |      |      |      |
|------------|------|------|------|------|------|------|------|
| 84" Height | 2073 | 2157 | 2240 | 2323 | 2422 | 2505 | 2590 |
| 80" Height | 1979 | 2060 | 2140 | 2219 | 2314 | 2393 | 2474 |
| 76" Height | 1888 | 1965 | 2041 | 2116 | 2208 | 2283 | 2361 |
| 72" Height | 1838 | 1911 | 1983 | 2055 | 2143 | 2215 | 2289 |
| WIDTH A+B  | 66"  | 72"  | 78"  | 84"  | 90"  | 96"  | 102" |

\* Three hinges are required on doors exceeding 80 lbs. or 28" in width or 84" height. Pricing includes third hinge where indicated.

**Notched panels, add \$250 for polished edge to prices listed above  
\$175 for swiped edge**



## AVAILABLE UPGRADES FOR GW MODELS

Finish options see page 29

Glass options see page 28

Accessory options see pages 29-30

Vents and Transoms see pages 26-27

GW models with panels - Openings up to 48" do not require a header. Over 48", a header is recommended. Add to list price:

- Aluminum Header - \$10 per ft.
- Brass Header - \$80 per ft.

Standard units are made without a threshold. Depending on base condition, slope, and water contact with door, a full bottom track may be necessary to prevent leakage. You MUST specify if needed.

### GW-1629

|            |       |       |       |       |       |       |
|------------|-------|-------|-------|-------|-------|-------|
| 84" Height | *1787 | *1842 | *1950 | *2004 | *2113 | *2469 |
| 80" Height | 1755  | 1807  | 1910  | 1962  | 2066  | 2118  |
| 76" Height | 1701  | 1750  | 1849  | 1898  | 1997  | 2046  |
| 72" Height | 1648  | 1695  | 1789  | 1835  | 1929  | 1976  |
| WIDTH      | 30"   | 36"   | 42"   | 48"   | 54"   | 60"   |

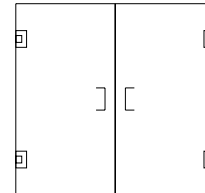

GW-1629  
French Doors

### GW-1627 • SOLID BRASS WALL CHANNEL

|            |      |      |      |      |      |
|------------|------|------|------|------|------|
| 84" Height | 1805 | 1912 | 2019 | 2126 | 2234 |
| 80" Height | 1753 | 1856 | 1960 | 2063 | 2167 |
| 76" Height | 1679 | 1779 | 1879 | 1979 | 2079 |
| 72" Height | 1606 | 1703 | 1799 | 1895 | 1991 |
| WIDTH      | 36"  | 42"  | 48"  | 54"  | 60"  |

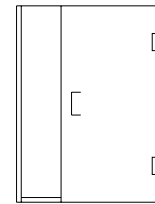

GW-1627  
Door & Panel with Wall Channel

### GW-1669-2/3 & GW-1669-2/3-B SOLID BRASS WALL CHANNEL

|            |      |      |      |      |      |      |
|------------|------|------|------|------|------|------|
| 92" Height | 2321 | 2435 | 2550 | 2805 | 2920 | 3035 |
| 88" Height | 2263 | 2374 | 2485 | 2736 | 2847 | 2959 |
| 84" Height | 2205 | 2313 | 2420 | 2667 | 2775 | 2883 |
| 80" Height | 2119 | 2223 | 2327 | 2404 | 2508 | 2612 |
| 76" Height | 2047 | 2148 | 2248 | 2322 | 2422 | 2522 |
| 72" Height | 1990 | 2086 | 2183 | 2253 | 2350 | 2446 |
| WIDTH A+B  | 42"  | 48"  | 54"  | 60"  | 66"  | 72"  |

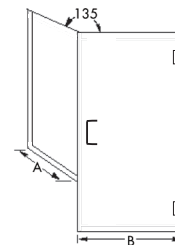

GW-1669-2/3-B  
Two-Thirds Neo-Angle with Buttress  
Panel and Wall Channel

### GW-1631 • SOLID BRASS WALL CHANNEL

|            |      |      |      |      |      |      |      |
|------------|------|------|------|------|------|------|------|
| 84" Height | 2638 | 2747 | 2855 | 2962 | 3086 | 3194 | 3303 |
| 80" Height | 2528 | 2634 | 2738 | 2842 | 2962 | 3066 | 3172 |
| 76" Height | 2420 | 2522 | 2622 | 2723 | 2839 | 2939 | 3041 |
| 72" Height | 2353 | 2452 | 2548 | 2645 | 2758 | 2854 | 2953 |
| WIDTH A+B  | 66"  | 72"  | 78"  | 84"  | 90"  | 96"  | 102" |

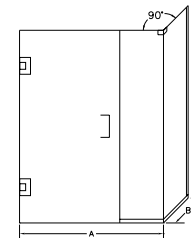

GW-1631-NB  
Corner Enclosure with Wall Channel  
and Top Mount Corner Clip

Additional width may require header  
Additional height - custom quote, please call factory

Notched panels, add \$250 for polished edge to prices listed above  
\$175 for swiped edge

BRASS WALL MOUNT HINGE DOORS

# BRASS WALL MOUNT HINGE DOORS

## Standard Features on GWP Models

- Solid Brass wall mounted hinges - dual acting
- Extruded Aluminum or Brass wall channel for stationary panel(s) where indicated
- Frameless 3/8" Clear glass with 90 degree edges
- Standard 24" door width on Door/Panel and Corner Enclosure models
- Aluminum Standard Finishes: Silver Anodized Aluminum; Gold Anodized Aluminum
- Solid Brass Standard Finishes: Polished Chrome; Satin Chrome; Polished Nickel; Satin Nickel
- Wall mount pivot dual action hinge system
- 6" C-Pull handle

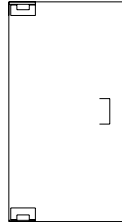

GWP-70  
Single Door

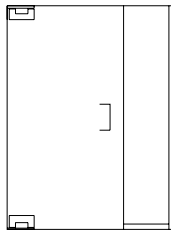

GWP-1627  
Door & Panel with Wall Channel

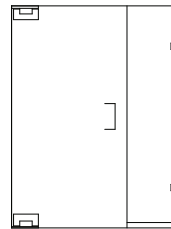

GWP-1627  
Door & Panel with Clips

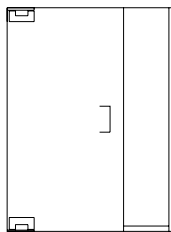

GWP-1627  
Door & Panel with Wall Channel

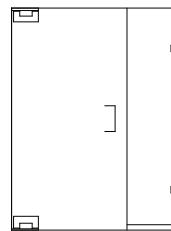

GWP-1627  
Door & Panel with Clips

### GWP-70

|            |      |      |      |      |      |
|------------|------|------|------|------|------|
| 84" Height | 1246 | 1274 | 1300 | 1326 | 1354 |
| 80" Height | 1214 | 1240 | 1266 | 1292 | 1316 |
| 76" Height | 1198 | 1222 | 1246 | 1270 | 1294 |
| 72" Height | 1194 | 1216 | 1240 | 1262 | 1286 |
| Width      | 24"  | 26"  | 28"  | 30"  | 32"  |

### GWP-1627 • ALUMINUM CHANNEL

|            |      |      |      |      |      |
|------------|------|------|------|------|------|
| 84" Height | 1653 | 1736 | 1819 | 1902 | 1985 |
| 80" Height | 1624 | 1704 | 1783 | 1862 | 1942 |
| 76" Height | 1567 | 1643 | 1718 | 1794 | 1870 |
| 72" Height | 1510 | 1582 | 1654 | 1726 | 1798 |
| Width      | 36"  | 42"  | 48"  | 54"  | 60"  |

### GWP-1627 • ALUMINUM BASE CHANNEL WITH CLIPS

|            |      |      |      |      |      |
|------------|------|------|------|------|------|
| 84" Height | 1842 | 1925 | 2006 | 2194 | 2277 |
| 80" Height | 1814 | 1892 | 1971 | 2051 | 2235 |
| 76" Height | 1756 | 1832 | 1907 | 1983 | 2164 |
| 72" Height | 1702 | 1774 | 1845 | 1917 | 2094 |
| Width      | 36"  | 42"  | 48"  | 54"  | 60"  |

### GWP-1627 • BRASS CHANNEL

|            |      |      |      |      |      |
|------------|------|------|------|------|------|
| 84" Height | 2055 | 2136 | 2218 | 2299 | 2380 |
| 80" Height | 2010 | 2088 | 2165 | 2243 | 2321 |
| 76" Height | 1936 | 2010 | 2084 | 2158 | 2232 |
| 72" Height | 1864 | 1934 | 2004 | 2074 | 2145 |
| Width      | 36"  | 42"  | 48"  | 54"  | 60"  |

### GWP-1627 • BRASS BASE CHANNEL & STATIONARY WALL CLIPS

|            |      |      |      |      |      |
|------------|------|------|------|------|------|
| 84" Height | 1955 | 2062 | 2170 | 2382 | 2489 |
| 80" Height | 1927 | 2031 | 2134 | 2238 | 2447 |
| 76" Height | 1871 | 1972 | 2072 | 2170 | 2375 |
| 72" Height | 1815 | 1912 | 2008 | 2104 | 2305 |
| Width      | 36"  | 42"  | 48"  | 54"  | 60"  |

## AVAILABLE UPGRADES FOR GWP MODELS

Finish options see page 29  
 Glass options see page 28  
 Accessory options see pages 29-30  
 Vents and Transoms see pages 26-27

GWP models with panels - Openings up to 48" do not require a header. Over 48" a header is recommended. Add to list price:

- Aluminum Header - \$10 per ft.
- Brass Header - \$80 per ft.
- Additional width may require header
- **Additional Height - Custom Quote, please call factory**
- **Notched panels, add \$250 for polished edge, \$175 for Swiped Edge**

Standard units are made without a threshold. Depending on base condition, slope, and water contact with door, a full bottom track many be necessary to prevent leakage. You **MUST** specify if needed.

### GWP-1629

|            |      |      |      |      |      |      |      |      |
|------------|------|------|------|------|------|------|------|------|
| 84" Height | 2360 | 2415 | 2523 | 2577 | 2686 | 2895 | 3032 | 3087 |
| 80" Height | 2335 | 2387 | 2490 | 2542 | 2646 | 2697 | 2985 | 3037 |
| 76" Height | 2281 | 2330 | 2429 | 2478 | 2577 | 2626 | 2909 | 2958 |
| 72" Height | 2228 | 2275 | 2369 | 2415 | 2509 | 2556 | 2679 | 2881 |
| WIDTH      | 30"  | 36"  | 42"  | 48"  | 54"  | 60"  | 66"  | 72"  |

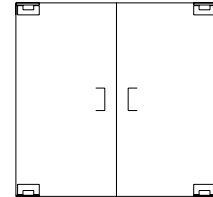

GWP-1629  
French Doors

### GWP-1631 • SOLID BRASS CHANNEL

|             |      |      |      |      |      |      |      |
|-------------|------|------|------|------|------|------|------|
| 84" Height  | 2912 | 3022 | 3131 | 3241 | 3322 | 3427 | 3537 |
| 80" Height  | 2803 | 2910 | 3015 | 3120 | 3198 | 3299 | 3405 |
| 76" Height  | 2695 | 2797 | 2899 | 3001 | 3075 | 3173 | 3275 |
| 72" Height  | 2628 | 2727 | 2825 | 2924 | 2994 | 3088 | 3186 |
| WIDTH A + B | 66"  | 72"  | 78"  | 84"  | 90"  | 96"  | 102" |

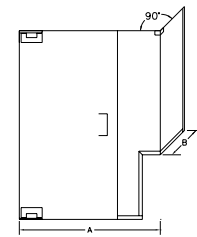

GWP-1631-NB  
Corner Enclosure with Wall Channel and Corner Clip

### GWP-1631 • SOLID BRASS BASE CHANNEL WITH CLIPS

|             |      |      |      |      |      |      |      |
|-------------|------|------|------|------|------|------|------|
| 84" Height  | 2704 | 2814 | 2924 | 3060 | 3168 | 3290 | 3399 |
| 80" Height  | 2612 | 2718 | 2824 | 2956 | 3060 | 3180 | 3286 |
| 76" Height  | 2522 | 2624 | 2726 | 2854 | 2956 | 3072 | 3172 |
| 72" Height  | 2472 | 2570 | 2670 | 2796 | 2892 | 3004 | 3102 |
| WIDTH A + B | 66"  | 72"  | 78"  | 84"  | 90"  | 96"  | 102" |

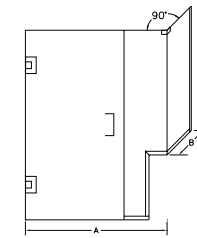

GWP-1631-NB  
Corner Enclosure with Wall Channel and Top Mount Corner Clip

### GWP-1631 ALUMINUM CHANNEL

|             |      |      |      |      |      |      |      |
|-------------|------|------|------|------|------|------|------|
| 84" Height  | 2350 | 2433 | 2516 | 2599 | 2680 | 2777 | 2860 |
| 80" Height  | 2258 | 2337 | 2417 | 2496 | 2574 | 2666 | 2746 |
| 76" Height  | 2168 | 2243 | 2319 | 2394 | 2468 | 2557 | 2633 |
| 72" Height  | 2118 | 2190 | 2262 | 2334 | 2405 | 2490 | 2542 |
| Width A + B | 66"  | 72"  | 78"  | 84"  | 90"  | 96"  | 102" |

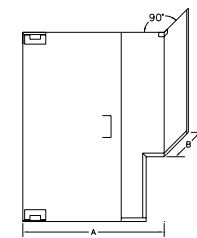

GWP-1631-NB  
Corner Enclosure with Buttress Return, Wall Channel & Corner Clip

### GWP-1631 ALUMINUM BASE CHANNEL & STATIONARY WALL CLIPS

|             |      |      |      |      |      |      |      |
|-------------|------|------|------|------|------|------|------|
| 84" Height  | 2478 | 2563 | 2648 | 2734 | 2816 | 2914 | 2999 |
| 80" Height  | 2366 | 2468 | 2550 | 2630 | 2709 | 2803 | 2885 |
| 76" Height  | 2296 | 2373 | 2452 | 2528 | 2604 | 2695 | 2772 |
| 72" Height  | 2248 | 2320 | 2394 | 2468 | 2540 | 2627 | 2702 |
| Width A + B | 66"  | 72"  | 78"  | 84"  | 90"  | 96"  | 102" |

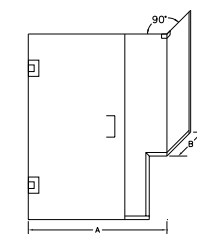

GWP-1631-NB  
Corner Enclosure with Buttress Return, Wall Channel & Corner Clip

BRASS WALL MOUNT HINGE DOORS

# BRASS GLASS TO GLASS HINGE DOORS

## Standard Features on GG Models

- Solid Brass glass to glass hinges - dual acting
- Extruded Aluminum or Brass base channel for stationary panel(s) where indicated
- Frameless 3/8" Door Clear glass with 90 degree edges, 1/2" Clear Panels
- Aluminum Standard Finishes: Silver Anodized Aluminum; Gold Anodized Aluminum
- Solid Brass Standard Finishes: Polished Chrome; Satin Chrome; Polished Nickel; Satin Nickel
- 6" C-Pull handle

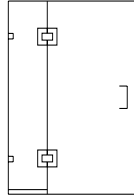

GG-1627  
Door & Panel Open Above  
with Wall Clips

| GG1627 • WITH WALL CLIPS |      |      |      |      |      |      |      |
|--------------------------|------|------|------|------|------|------|------|
| 84" Height               | 1856 | 1959 | 2062 | 2165 | 2268 | 2385 | 2487 |
| 80" Height               | 1826 | 1924 | 2022 | 2121 | 2219 | 2332 | 2430 |
| 76" Height               | 1767 | 1861 | 1954 | 2048 | 2142 | 2250 | 2344 |
| 72" Height               | 1709 | 1798 | 1887 | 1976 | 2065 | 2169 | 2258 |
| WIDTH                    | 36"  | 42"  | 48"  | 54"  | 60"  | 66"  | 72"  |

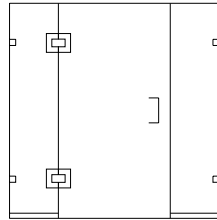

GG-1628  
Full Height Panel, Door,  
Panel with Wall Clips

| GG-1628 • WITH WALL CLIPS |      |      |      |      |      |      |      |
|---------------------------|------|------|------|------|------|------|------|
| 84" Height                | 2563 | 2633 | 2769 | 2838 | 2974 | 3044 | 3194 |
| 80" Height                | 2475 | 2542 | 2672 | 2738 | 2868 | 2935 | 3079 |
| 76" Height                | 2388 | 2452 | 2576 | 2639 | 2763 | 2827 | 2965 |
| 72" Height                | 2343 | 2403 | 2521 | 2582 | 2700 | 2760 | 2893 |
| WIDTH                     | 48"  | 54"  | 60"  | 66"  | 72"  | 78"  | 84"  |

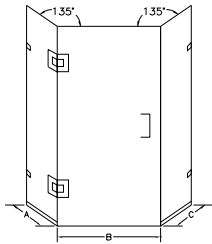

GG-1669  
Neo-Angle with Header

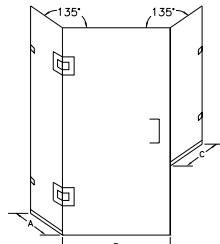

GG-1669-B  
Neo-Angle with Buttress  
Panel

| GG-1669 & GG-1669-B ALUMINUM CHANNEL WITH CLIPS |      |      |      |      |      |      |      |
|---|------|------|------|------|------|------|------|
| 84" Height                                      | 3094 | 3189 | 3300 | 3379 | 3490 | 3585 | 3687 |
| 80" Height                                      | 2982 | 3072 | 3178 | 3254 | 3360 | 3451 | 3549 |
| 76" Height                                      | 2859 | 2945 | 3046 | 3118 | 3219 | 3306 | 3399 |
| 72" Height                                      | 2789 | 2871 | 2968 | 3036 | 3132 | 3215 | 3304 |
| WIDTH A+B+C                                     | 60"  | 66"  | 72"  | 78"  | 84"  | 90"  | 96"  |

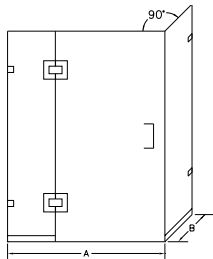

GG-1631  
Corner Enclosure Open  
Above with Wall Clips

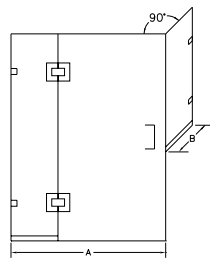

GG-1631-B  
Corner Enclosure with  
Buttress Return

| GG-1631 & GG-1631-B ALUMINUM CHANNEL WITH CLIPS |      |      |      |      |      |      |      |
|---|------|------|------|------|------|------|------|
| 92" Height                                      | 2957 | 3069 | 3181 | 3293 | 3405 | 3517 | 3628 |
| 88" Height                                      | 2900 | 3007 | 3115 | 3222 | 3329 | 3437 | 3544 |
| 84" Height                                      | 2843 | 2946 | 3048 | 3151 | 3254 | 3357 | 3460 |
| 80" Height                                      | 2743 | 2841 | 2939 | 3037 | 3136 | 3234 | 3332 |
| 76" Height                                      | 2644 | 2737 | 2831 | 2925 | 3019 | 3112 | 3206 |
| 72" Height                                      | 2588 | 2676 | 2765 | 2854 | 2943 | 3032 | 3122 |
| WIDTH A+B                                       | 66"  | 72"  | 78"  | 84"  | 90"  | 96"  | 102" |

Notched panels, add \$250 for polished edge to prices listed above  
\$175 for swiped edge

## AVAILABLE UPGRADES FOR GG MODELS

Finish options see page 29

Glass options see page 28

Accessory options see pages 29-30

Vents and Transoms see pages 26-27

GG models - Openings up to 36" do not require a header. Over 36", a header is recommended or panels must run full height.

- Aluminum Header \$10 per ft / Brass Header \$80 per ft add to list price.
- 3/8" Clear Door
- 1/2" Clear Panels

Standard units are made without a threshold. Depending on base condition, slope, and water contact with door, a full bottom track may be necessary to prevent leakage. You MUST specify if needed.

### GG1627 • WALL CLIPS

|            |      |      |      |      |      |      |      |
|------------|------|------|------|------|------|------|------|
| 84" Height | 2005 | 2132 | 2259 | 2386 | 2513 | 2655 | 2782 |
| 80" Height | 1974 | 2097 | 2220 | 2342 | 2465 | 2602 | 2724 |
| 76" Height | 1915 | 2033 | 2151 | 2269 | 2388 | 2520 | 2638 |
| 72" Height | 1857 | 1971 | 2084 | 2198 | 2311 | 2439 | 2553 |
| WIDTH      | 36"  | 42"  | 48"  | 54"  | 60"  | 66"  | 72"  |

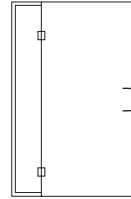

GG-1627  
Full Height Door & Panel  
with Wall Channel

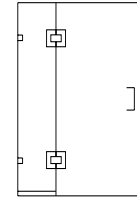

GG-1627  
Door & Panel Open Above  
with Wall Clips

### GG-1628 • WALL CLIPS

|            |      |      |      |      |      |      |      |
|------------|------|------|------|------|------|------|------|
| 84" Height | 2407 | 2551 | 2798 | 2892 | 3053 | 3147 | 3323 |
| 80" Height | 2543 | 2637 | 2701 | 2792 | 2947 | 3038 | 3207 |
| 76" Height | 2368 | 2546 | 2605 | 2693 | 2842 | 2930 | 3093 |
| 72" Height | 2323 | 2456 | 2551 | 2635 | 2779 | 2864 | 3021 |
| WIDTH      | 48"  | 54"  | 60"  | 66"  | 72"  | 78"  | 84"  |

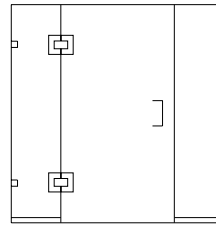

GG-1628  
Panel, Door, Panel Open Above with  
Wall Clips

### GG-1669 & GG-1669-B WALL CLIPS

|             |      |      |      |      |      |      |      |
|-------------|------|------|------|------|------|------|------|
| 92" Height  | 3381 | 3501 | 3655 | 3742 | 3895 | 4015 | 4117 |
| 88" Height  | 3310 | 3426 | 3575 | 3658 | 3806 | 3922 | 4021 |
| 84" Height  | 3240 | 3351 | 3495 | 3574 | 3718 | 3829 | 3925 |
| 80" Height  | 3169 | 3276 | 3415 | 3491 | 3629 | 3737 | 3830 |
| 76" Height  | 3098 | 3201 | 3335 | 3407 | 3541 | 3644 | 3734 |
| 72" Height  | 3027 | 3126 | 3255 | 3323 | 3452 | 3551 | 3638 |
| WIDTH A+B+C | 60"  | 66"  | 72"  | 78"  | 84"  | 90"  | 96"  |

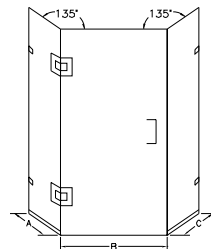

GG-1669  
Neo-Angle with Header

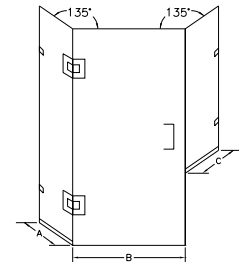

GG-1669-B  
Neo-Angle with Buttruss  
Panel and Header

### GG-1631 & GG-1631-B WALL CLIPS

|            |      |      |      |      |      |      |      |
|------------|------|------|------|------|------|------|------|
| 92" Height | 3181 | 3318 | 3454 | 3591 | 3728 | 3864 | 4001 |
| 88" Height | 3124 | 3256 | 3388 | 3520 | 3652 | 3784 | 3917 |
| 84" Height | 3067 | 3194 | 3322 | 3449 | 3577 | 3705 | 3832 |
| 80" Height | 2966 | 3089 | 3212 | 3336 | 3459 | 3582 | 3705 |
| 76" Height | 2867 | 2986 | 3104 | 3223 | 3342 | 3460 | 3579 |
| 72" Height | 2810 | 2924 | 3038 | 3152 | 3266 | 3380 | 3494 |
| WIDTH A+B  | 66"  | 72"  | 78"  | 84"  | 90"  | 96"  | 102" |

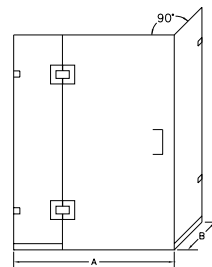

GG-1631  
Corner Enclosure Open  
Above with Wall Clips

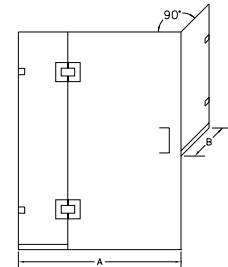

GG-1631-B  
Corner Enclosure with Buttruss  
Return, Full Height Panels

Notched panels, add \$250 for polished edge to prices listed above  
\$175 for swiped edge

# BRASS GLASS TO GLASS HINGE DOORS

## Standard Features on GG Models

- Solid Brass glass to glass hinges - dual acting
- Extruded Aluminum or Brass base channel for stationary panel(s) where indicated
- Frameless 3/8" Door Clear glass with 90 degree edges, 1/2" Clear Panel - Clips
- Standard 24" door width
- Aluminum Standard Finishes: Silver Anodized Aluminum; Gold Anodized Aluminum
- Solid Brass Standard Finishes: Polished Chrome; Satin Chrome; Polished Nickel; Satin Nickel
- 6" C-Pull handle

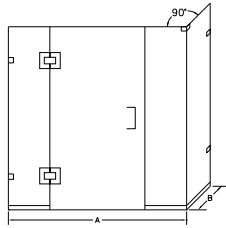

GG-1632  
Corner Enclosure with Top Mount  
Corner Clip & Stationary Wall Clips

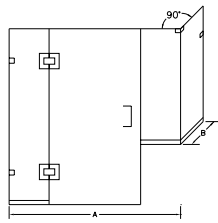

GG-1632 -B  
Corner Enclosure with Top Mount  
Corner Clip & Stationary Wall Clips

### GG-1632 & GG-1632-B WALL CLIPS

|            |      |      |      |      |      |      |      |
|------------|------|------|------|------|------|------|------|
| 84" Height | 3241 | 3344 | 3447 | 3549 | 3618 | 3721 | 3824 |
| 80" Height | 3116 | 3215 | 3313 | 3411 | 3477 | 3575 | 3674 |
| 76" Height | 3049 | 3143 | 3236 | 3330 | 3393 | 3487 | 3581 |
| 72" Height | 2926 | 3015 | 3104 | 3194 | 3254 | 3343 | 3432 |
| WIDTH A+B  | 72"  | 78"  | 84"  | 90"  | 96"  | 102" | 108" |

\* Three hinges are required on doors exceeding 80 lbs. or 28" in width. See Weight Data on page 8. Call for pricing.

### GG-1632 & GG-1632-B WALL CLIPS

|            |      |      |      |      |      |      |      |
|------------|------|------|------|------|------|------|------|
| 84" Height | 3461 | 3588 | 3716 | 3843 | 3937 | 4065 | 4193 |
| 80" Height | 3336 | 3459 | 3582 | 3705 | 3796 | 3919 | 4042 |
| 76" Height | 3269 | 3387 | 3506 | 3624 | 3712 | 3830 | 3949 |
| 72" Height | 3146 | 3260 | 3374 | 3488 | 3572 | 3686 | 3800 |
| WIDTH A+B  | 72"  | 78"  | 84"  | 90"  | 96"  | 102" | 108" |

Notched panels, add \$250 for polished edge to prices listed above  
\$175 for swiped edge

## AVAILABLE UPGRADES FOR GGP MODELS

Finish options see page 29

Glass options see page 28

Accessory options see pages 29-30

Vents and Transoms see pages 26-27

GGP models - Openings up to 36" do not require a header. Over 36", a header is recommended or panels must run full height.

- Aluminum Header \$10 per ft / Brass Header \$80 per ft add to list price.
- 3/8" Clear Door
- 1/2" Clear Panels

Standard units are made without a threshold. Depending on base condition, slope, and water contact with door, a full bottom track may be necessary to prevent leakage. You MUST specify if needed.

### GGP-1628 • WALL CLIPS

|            |      |      |      |      |      |      |      |
|------------|------|------|------|------|------|------|------|
| 84" Height | 2864 | 2934 | 3070 | 3140 | 3276 | 3346 | 3415 |
| 80" Height | 2570 | 2637 | 2767 | 2834 | 2964 | 3031 | 3097 |
| 76" Height | 2487 | 2551 | 2675 | 2739 | 2863 | 2927 | 2990 |
| 72" Height | 2447 | 2507 | 2625 | 2686 | 2804 | 2865 | 2925 |
| WIDTH      | 42"  | 48"  | 54"  | 60"  | 66"  | 72"  | 76"  |

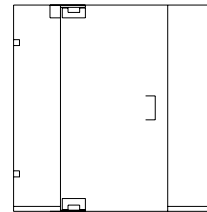

GGP-1628  
Full Height Panel, Door, Panel with Wall Channel Clips

### GGP-1631 & GGP-1631-B WALL CLIPS

|            |      |      |      |      |      |      |      |
|------------|------|------|------|------|------|------|------|
| 84" Height | 3105 | 3210 | 3315 | 3418 | 3522 | 3625 | 3745 |
| 80" Height | 2899 | 3000 | 3102 | 3199 | 3299 | 3397 | 3512 |
| 76" Height | 2883 | 2979 | 3076 | 3170 | 3116 | 3359 | 3469 |
| 72" Height | 2825 | 2917 | 3009 | 3099 | 3189 | 3278 | 3384 |
| WIDTH      | 66"  | 72"  | 78"  | 84"  | 90"  | 96"  | 102" |

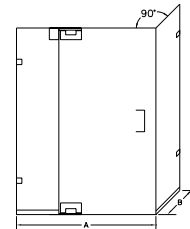

GGP-1631  
Corner Enclosure Open Above with Wall Clips

### GGP-1632 & GGP-1632-B WALL CLIPS

|            |      |      |      |      |      |      |      |
|------------|------|------|------|------|------|------|------|
| 84" Height | 2864 | 2934 | 3070 | 3140 | 3276 | 3346 | 3415 |
| 80" Height | 2570 | 2637 | 2767 | 2834 | 2964 | 3031 | 3097 |
| 76" Height | 2487 | 2551 | 2675 | 2739 | 2863 | 2927 | 2990 |
| 72" Height | 2447 | 2507 | 2625 | 2686 | 2804 | 2865 | 2925 |
| WIDTH      | 66"  | 72"  | 78"  | 84"  | 90"  | 96"  | 102" |

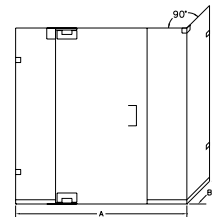

GGP-1632  
Corner Enclosure Open Above with Corner and Wall Clips

### GGP-1669 & GGP-1669-B WALL CLIPS

|            |      |      |      |      |      |      |      |
|------------|------|------|------|------|------|------|------|
| 84" Height | 3540 | 3778 | 3915 | 3995 | 4064 | 4201 | 4271 |
| 80" Height | 3399 | 3465 | 3596 | 3671 | 3738 | 3869 | 3935 |
| 76" Height | 3288 | 3351 | 3476 | 3548 | 3611 | 3736 | 3799 |
| 72" Height | 3230 | 3291 | 3409 | 3478 | 3538 | 3657 | 3717 |
| WIDTH      | 60"  | 66"  | 72"  | 78"  | 84"  | 90"  | 96"  |

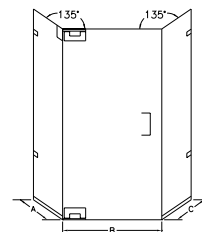

GGP-1669  
Neo-Angle with Header

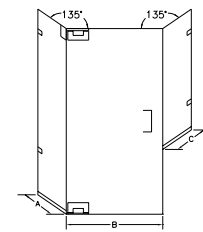

GGP-1669-B  
Neo-Angle with Buttress Panel and Header

### GGP1627 • WALL CLIPS

|            |      |      |      |      |      |      |      |
|------------|------|------|------|------|------|------|------|
| 84" Height | 2082 | 2150 | 2254 | 2357 | 2460 | 2587 | 2487 |
| 80" Height | 1949 | 2015 | 2113 | 2212 | 2310 | 2409 | 2430 |
| 76" Height | 1893 | 1955 | 2049 | 2143 | 2237 | 2331 | 2344 |
| 72" Height | 1837 | 1897 | 1986 | 2076 | 2165 | 2255 | 2258 |
| WIDTH      | 32"  | 36"  | 42"  | 48"  | 54"  | 60"  | 72"  |

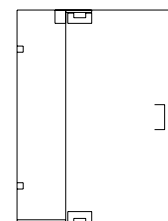

GGP-1627  
Door & Panel Open Above with Wall Clips

# SLIDING ENCLOSURES - SOLID BRASS

## Standard Features on G-CT, G-CT-636, G-CS, and G-CS-1648 Models

- Solid brass variation of our popular aluminum Centec Series
- Complete with solid brass header, side jambs, easy clean track & hardware
- 1/4" and 3/8" Clear glass
- Round designer header, Flat Header available at no extra charge
- Standard Finishes: Polished Chrome; Satin Chrome; Polished Nickel; Satin Nickel
- Modern towel bars

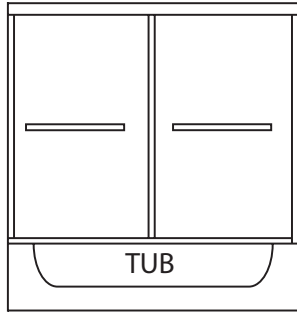

G-CT  
Tub Enclosure

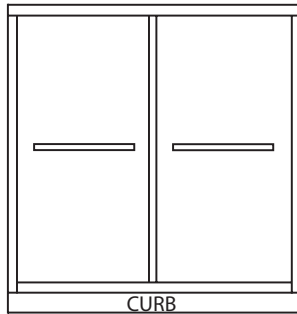

G-CS  
Shower Stall Enclosure

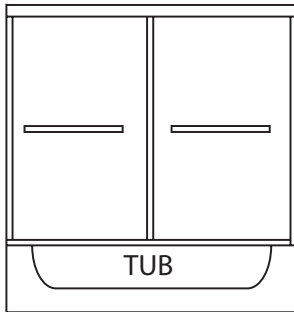

G-CT-636  
Corner Tub Enclosure

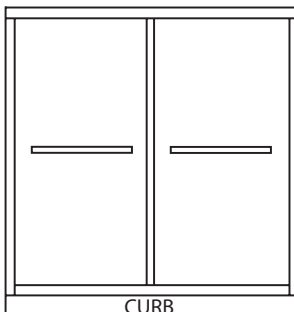

G-CS-1648  
Corner Shower Stall  
Enclosure

### G-CT • 1/4" GLASS

|                |      |      |      |      |
|----------------|------|------|------|------|
| 72" height     | 2850 | 3012 | 3154 | 3330 |
| 68" height     | 2775 | 2936 | 3076 | 3250 |
| 64" height     | 2701 | 2859 | 2998 | 3170 |
| 62 3/4" height | 2677 | 2834 | 2973 | 3144 |
| 57 3/4" height | 2558 | 2713 | 2850 | 3019 |
| 56" height     | 2521 | 2674 | 2811 | 2979 |
| WIDTH          | 54"  | 60"  | 66"  | 72"  |

### G-CS • 1/4" GLASS

|                |      |      |      |      |      |      |
|----------------|------|------|------|------|------|------|
| 80" height     | 2703 | 2870 | 3013 | 3180 | 3324 | 3505 |
| 76" height     | 2617 | 2782 | 2924 | 3089 | 3232 | 3410 |
| 72" height     | 2546 | 2709 | 2850 | 3012 | 3154 | 3330 |
| 70 3/4" height | 2524 | 2686 | 2826 | 2988 | 3129 | 3304 |
| 68" height     | 2475 | 2635 | 2775 | 2936 | 3076 | 3250 |
| 66" height     | 2439 | 2598 | 2738 | 2897 | 3037 | 3210 |
| WIDTH          | 42"  | 48"  | 54"  | 60"  | 66"  | 72"  |

### G-CT • 3/8" GLASS

|                |      |      |      |      |
|----------------|------|------|------|------|
| 72" height     | 2609 | 2778 | 2927 | 3111 |
| 68" height     | 2547 | 2715 | 2862 | 3044 |
| 64" height     | 2486 | 2651 | 2797 | 2977 |
| 62 3/4" height | 2467 | 2630 | 2776 | 2954 |
| 57 3/4" height | 2347 | 2508 | 2653 | 2829 |
| 56" height     | 2316 | 2476 | 2621 | 2795 |
| WIDTH          | 54"  | 60"  | 66"  | 72"  |

### G-CS • 3/8" GLASS

|                |      |      |      |      |      |      |
|----------------|------|------|------|------|------|------|
| 80" height     | 3017 | 3257 | 3444 | 3683 | 3870 | 4124 |
| 76" height     | 2922 | 3156 | 3340 | 3574 | 3759 | 4008 |
| 72" height     | 2841 | 3070 | 3252 | 3481 | 3662 | 3907 |
| 70 3/4" height | 2812 | 3039 | 3219 | 3446 | 3626 | 3868 |
| 68" height     | 2760 | 2984 | 3163 | 3387 | 3566 | 3805 |
| 66" height     | 2719 | 2941 | 3119 | 3340 | 3518 | 3755 |
| WIDTH          | 42"  | 48"  | 54"  | 60"  | 66"  | 72"  |



**AVAILABLE UPGRADES FOR G-CT,  
G-CT-636, G-CS, AND G-CS-1648  
MODELS**

Finish options see page 29  
Glass options see page 28  
Accessory options see pages 29-30  
Vents and Transoms see pages 26-27

Glasstec Sliding Doors come standard with a solid brass round header. A solid brass flat beveled header is available at no extra charge. Please specify flat header when ordering. All orders unspecified will include round header.

Standard Finishes:  
Polished Chrome • Satin Chrome • Polished Nickel • Satin Nickel

**G-CT-636 AND G-CT-636-B • 1/4" GLASS\***

|                |      |      |      |      |      |      |
|----------------|------|------|------|------|------|------|
| 72" Height     | 5056 | 5311 | 5474 | 5615 | 5792 | 6034 |
| 68" Height     | 4907 | 5157 | 5318 | 5458 | 5633 | 5869 |
| 64" Height     | 4774 | 5022 | 5180 | 5319 | 5492 | 5725 |
| 62 3/4" Height | 4745 | 4992 | 5149 | 5288 | 5459 | 5693 |
| 57 3/4" Height | 4520 | 4762 | 4917 | 5055 | 5224 | 5452 |
| 56" Height     | 4432 | 4671 | 4825 | 4962 | 5130 | 5355 |
| WIDTH A+B      | 84"  | 90"  | 96"  | 102" | 108" | 114" |

**G-CS-1648 AND G-CS-1648-B • 1/4" GLASS\***

|                |      |      |      |      |      |      |
|----------------|------|------|------|------|------|------|
| 80" Height     | 5010 | 5177 | 5321 | 5582 | 5749 | 5996 |
| 76" Height     | 4881 | 5046 | 5188 | 5447 | 5612 | 5856 |
| 72" Height     | 4752 | 4914 | 5056 | 5311 | 5474 | 5715 |
| 70 3/4" Height | 4708 | 4869 | 5010 | 5263 | 5425 | 5663 |
| 68" Height     | 4606 | 4767 | 4907 | 5157 | 5318 | 5553 |
| 66" Height     | 4549 | 4709 | 4849 | 5099 | 5258 | 5494 |
| WIDTH A+B      | 72"  | 78"  | 84"  | 90"  | 96"  | 102" |

**G-CT-636 AND G-CT-636-B • 3/8" GLASS**

|                |      |      |      |      |      |      |
|----------------|------|------|------|------|------|------|
| 72" Height     | 5491 | 5733 | 5944 | 6110 | 6322 | 6563 |
| 68" Height     | 5322 | 5558 | 5764 | 5928 | 6135 | 6370 |
| 64" Height     | 5168 | 5401 | 5603 | 5764 | 5966 | 6199 |
| 62 3/4" Height | 5128 | 5361 | 5561 | 5721 | 5920 | 6153 |
| 57 3/4" Height | 4930 | 5158 | 5352 | 5509 | 5704 | 5932 |
| 56" Height     | 4845 | 5070 | 5262 | 5418 | 5610 | 5835 |
| WIDTH A+B      | 84"  | 90"  | 96"  | 102" | 108" | 114" |

**G-CS-1648 AND G-CS-1648-B • 3/8" GLASS**

|                |      |      |      |      |      |      |
|----------------|------|------|------|------|------|------|
| 80" Height     | 5406 | 5628 | 5799 | 6045 | 6267 | 6514 |
| 76" Height     | 5260 | 5476 | 5645 | 5889 | 6106 | 6350 |
| 72" Height     | 5114 | 5326 | 5491 | 5733 | 5944 | 6186 |
| 70 3/4" Height | 5062 | 5271 | 5435 | 5674 | 5883 | 6122 |
| 68" Height     | 4952 | 5158 | 5322 | 5558 | 5764 | 6000 |
| 66" Height     | 4887 | 5091 | 5253 | 5489 | 5693 | 5929 |
| WIDTH A+B      | 72"  | 78"  | 84"  | 90"  | 96"  | 102" |

G-CT-636-B  
Corner Tub Enclosure with  
Buttress Return  
\* Return panel is 3/8"  
glass

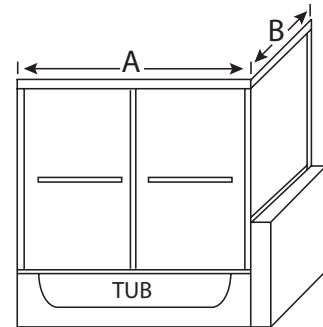

G-CS-1648-B  
Corner Shower Stall  
Enclosure with Buttress  
Return

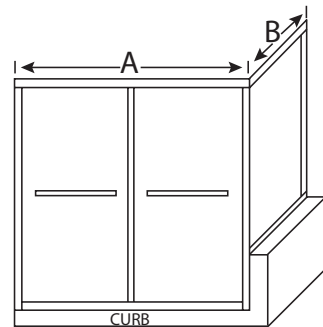

G-CT-636-B  
Corner Tub Enclosure with  
Buttress Return  
\* Return panel is 3/8"  
glass

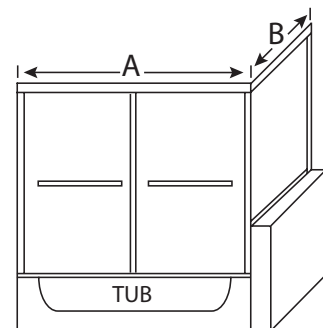

G-CS-1648-B  
Corner Shower Stall  
Enclosure with Buttress  
Return  
\* Return panel is 3/8"  
glass

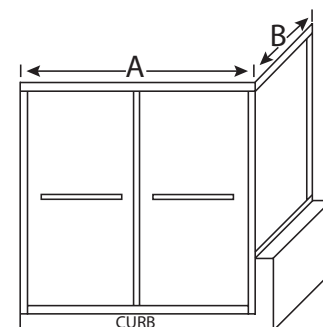

SLIDING ENCLOSURES

# JAMB MOUNT DOOR / SPRAY PANELS

## GWS-70 - Jamb Mount Brass Hinge Doors

- Two Solid Brass out swing, jamb mount hinges
- Extruded Aluminum jambs
- Continuous hinge & striker jamb for a watertight seal or steam enclosure
- Clear polycarbonate drip cap seals the bottom
- 10 degree positive closure; self closing from 20 degrees
- Frameless 3/8" Clear glass with 90 degree edges
- 6" C-Pull handle

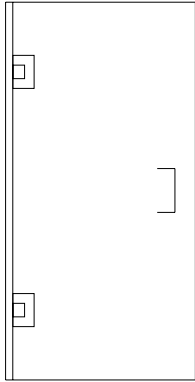

| GWS-70 • ALUMINUM CHANNEL<br>SILVER ANODIZED • GOLD ANODIZED |      |      |      |      |
|--|------|------|------|------|
| 84" Height   | 1883 | 1917 | 1950 | 1983 |
| 80" Height   | 1861 | 1893 | 1925 | 1957 |
| 76" Height   | 1839 | 1869 | 1899 | 1930 |
| 72" Height   | 1777 | 1806 | 1835 | 1864 |
| WIDTH  | 24"  | 26"  | 28"  | 30"  |
| Satin Nickel Aluminum finish - Add \$275                     |      |      |      |      |
| Oil Rubbed Bronze Paint on Aluminum - Add \$500              |      |      |      |      |

## GWS-100 - Hinged Spray Panel

- Two Solid Brass dual swing, wall mount hinges
- 30" width x 60" height - standard size
- Frameless 3/8" Clear glass
- 10 degree radius corner
- Clear polycarbonate drip cap seals the bottom
- Standard Finishes: Polished Chrome; Satin Chrome; Polished Nickel; Satin Nickel
- Polished Brass, Satin Brass - add 20%; 24K Gold, Antique Brass, Oil Rubbed Bronze - call for quote
- Custom glass sizes and options available... call for quote

| Without Pull Knob | With Pull Knob |
|-------------------|----------------|
| 800               | 850            |



## GSP-100 - Stationary Spray Panel

- Frameless 3/8" Clear 90 degree glass
- Extruded aluminum or brass wall channels for two sided mount
- **Please specify 2, 3 or 4 sided mount**
- We recommend soffit channel for panels over 36" wide - consult factory for pricing
- Available with Radius Corner



| GSP-100 • SOLID BRASS CHANNEL POLISHED OR<br>SATIN CHROME • POLISHED OR SATIN NICKEL |     |     |                                |      |      |
|--|-----|-----|--------------------------------|------|------|
| 72" Height   | 891 | 982 | 1073                           | 1163 | 1254 |
| 68" Height   | 871 | 956 | 1042                           | 1128 | 1214 |
| 64" Height   | 850 | 931 | 1012                           | 1093 | 1174 |
| 60" Height   | 830 | 906 | 982                            | 1057 | 1133 |
| 56" Height   | 810 | 881 | 951                            | 1022 | 1093 |
| WIDTH  | 24" | 30" | 36"                            | 42"  | 48"  |
| Colortec Paint - Add \$150   |     |     | Custom Paint Match - Add \$450 |      |      |
| Antique Brass; Oil Rubbed Bronze; 24K Gold - Call for pricing                        |     |     |                                |      |      |

| GSP-100 • ALUMINUM CHANNEL<br>SILVER ANODIZED • GOLD ANODIZED |     |     |                                |     |     |
|---|-----|-----|--------------------------------|-----|-----|
| 64" Height  | 528 | 583 | 661                            | 747 | 834 |
| 60" Height  | 518 | 573 | 628                            | 709 | 791 |
| 56" Height  | 508 | 563 | 618                            | 673 | 747 |
| WIDTH   | 24" | 30" | 36"                            | 42" | 48" |
| Satin Nickel; Satin Chrome Aluminum finish - Add \$35         |     |     |                                |     |     |
| Colortec Paint - Add \$150                                    |     |     | Custom Paint Match - Add \$450 |     |     |

# STEAM VENTS

**STEAM VENTS ARE AVAILABLE ON ALL FRAMELESS HINGED MODELS  
WHEN FULL FLOOR TO CEILING GLASS IS BEING UTILIZED.**

## GCWWV - Glasstec Clamp Wall to Wall Vent

- Solid Brass clamp hinges
- Maximum width 30", maximum height 12"
- 3/4" finger pull standard
- Standard finishes: Polished Chrome, Satin Chrome, Polished Nickel, Satin Nickel
- Upgrade finishes: add as additional panel when calculating upgrade finish price

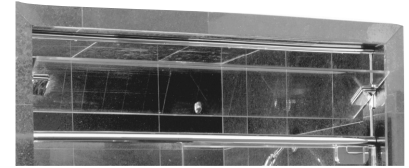

**Wall to Wall**

| 3/8" Glass | 1/2" Glass |
|------------|------------|
| 600        | 625        |

## GCGWV - Glasstec Clamp Glass to Wall Vent

- Solid Brass clamp hinges
- 24" maximum width x 12" maximum height
- Must attach to a minimum 6" panel
- 3/4" finger pull standard
- Standard finishes: Polished Chrome, Satin Chrome, Polished Nickel, Satin Nickel
- Upgrade finishes: add as additional panel when calculating upgrade finish price

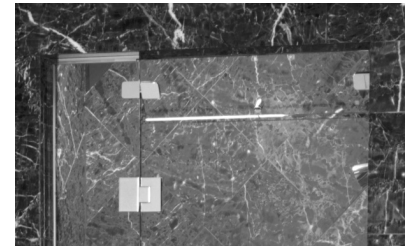

**Glass to Wall**

| 3/8" Glass | 1/2" Glass |
|------------|------------|
| 650        | 675        |

## GCGGV - Glasstec Clamp Glass to Glass Vent

- Solid Brass clamp hinges
- 24" maximum width x 12" maximum height
- Must attach to a minimum 6" panel
- 3/4" finger pull standard
- Standard finishes: Polished Chrome, Satin Chrome, Polished Nickel, Satin Nickel
- Upgrade finishes: add as additional panel when calculating upgrade finish price



**Glass to Glass**

|              | 3/8" Glass | 1/2" Glass |
|--------------|------------|------------|
| In-Line 180° | 708        | 735        |
| Neo - 135°   | 710        | 738        |

## GCEV - Glasstec Clamp Edge Vent

- Solid Brass clamp hinges
- 12" maximum width x 8" maximum height
- Main panel must have 6" of glass on each side of vent
- 3/4" finger pull standard
- Standard finishes: Polished Chrome, Satin Chrome, Polished Nickel, Satin Nickel
- Upgrade finishes: add as additional panel when calculating upgrade finish price

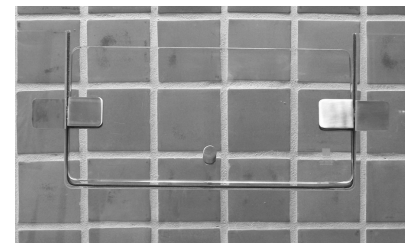

**Edge**

| 3/8" Glass | 1/2" Glass |
|------------|------------|
| 536        | 608        |

Recommended for stationary panels

# STEAM VENTS & STATIONARY TRANSOM

**STEAM VENTS ARE AVAILABLE ON ALL FRAMELESS HINGED MODELS  
WHEN FULL FLOOR TO CEILING GLASS IS BEING UTILIZED.**

## GCIV - Glasstec Clamp Interior Vent

- Solid Brass clamp hinges
- 12" maximum width x 8" maximum height
- Main panel must have 6" of glass on each side of vent
- 3/4" finger pull standard
- Standard finishes: Polished Chrome, Satin Chrome, Polished Nickel, Satin Nickel
- Upgrade finishes: add as additional panel when calculating upgrade finish price



**Interior**

|            |            |
|------------|------------|
| 3/8" Glass | 1/2" Glass |
| 1683       | 1810       |

Recommended for stationary panels

## GPV - Glasstec Pivot Vent

- Solid Brass pivot hinges
- 30" maximum width x 20" maximum height
- Full header above and below pivot vent
- Standard finishes: Polished Chrome, Satin Chrome, Polished Nickel, Satin Nickel
- Upgrade finishes: add as additional panel when calculating upgrade finish price



**Pivot**

|            |            |
|------------|------------|
| 3/8" Glass | 1/2" Glass |
| 800        | 830        |

## GST-98 - Stationary Transom

- Standard aluminum finishes: Silver Anodized Aluminum, Gold Anodized Aluminum
- Standard brass finishes: Polished Chrome, Satin Chrome, Polished Nickel, Satin Nickel
- Upgrade finishes: add as additional panel when calculating upgrade finish price
- Transoms hitting at angle, add \$1.50 per inch miter charge
- Vertical channels optional, please specify

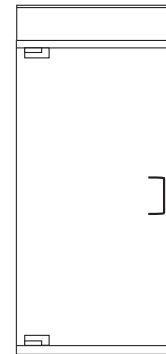

Stationary  
Transom  
above GP-70

| ALUMINUM CHANNELS - 3/8" CLEAR |     |     |
|--------------------------------|-----|-----|
| 24" Height                     | 208 | 338 |
| 12" Height                     | 155 | 215 |
| WIDTH                          | 30" | 60" |

| BRASS CHANNELS - 3/8" CLEAR |     |     |
|-----------------------------|-----|-----|
| 24" Height                  | 408 | 740 |
| 12" Height                  | 353 | 616 |
| WIDTH                       | 30" | 60" |

## Options Available ONLY as Indicated on Product Page



Clear (Standard)



Bubble



Antique



Bronze/Grey Tint



Rain

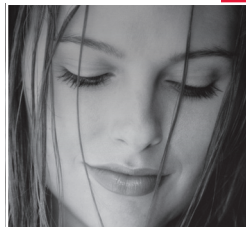

Starfire

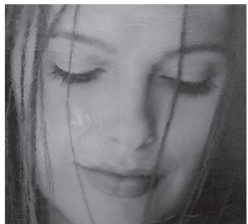

Glue Chip



Bisselux

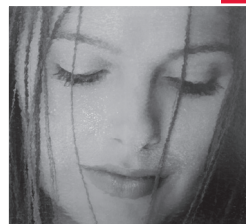

Aquatic  
(3/8" Glass only)



Cascade



Mist



GeoGlass

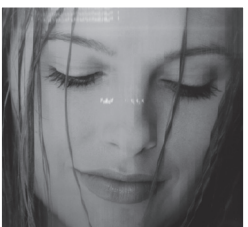

Vertical Wave



Pattern 62  
(1/4" Glass only)



Reed  
(1/4" Glass only)

Decorative Glass: Please see product page for glass upgrades available on the model you are ordering

Sliders: start with 1/4" base price then calculate sq. ft. (see formula). Glass price from grid below x total sq. ft. = glass up charge to base price. 1/4" & 3/8" ONLY.

Hinged Models: start with 3/8" base price then calculate Sq. Ft. (see formula). Glass price from grid below x total sq. ft. = glass up charge to base price. 3/8" & 1/2" ONLY.

1/2" Glass available on GP/GPW/GW/GG models as an upgrade to 3/8" clear glass. Not available on GAP and sliding door models.

### DECORATIVE GLASS

|               | 1/4"                             | 3/8" | 1/2" |
|---------------|----------------------------------|------|------|
| Clear         | std                              | std  | \$8  |
| Bubble        | \$14                             | \$16 | \$35 |
| Antique       | Consult Factory for Availability |      |      |
| Bronze Tint   | \$8                              | \$23 | \$35 |
| Grey Tint     | \$8                              | \$23 | \$35 |
| Rain          | \$8                              | \$16 | N/A  |
| Starphire     | \$18                             | \$25 | \$35 |
| Glue Chip     | \$25                             | \$35 | N/A  |
| Bisselux      | \$28                             | \$46 | \$85 |
| Aquatic       | N/A                              | \$36 | N/A  |
| Cascade       | \$28                             | \$36 | N/A  |
| Satin Etch    | \$26                             | \$30 | \$36 |
| Geo Glass*    | \$22                             | \$30 | N/A  |
| Vertical Wave | Consult Factory for Availability |      |      |
| Pattern 62    | \$12                             | \$26 | N/A  |
| Reed          | \$18                             | N/A  | N/A  |

\* GeoGlass available on sliders and model 70 only.

A number of other glass options are available. Contact factory for prices.

**Formula for Square Feet:**  
**Door Width in inches x Door Height in inches ÷ 144 = Square Feet**

**Example:**  
**A door of 28" width and 80" height = 16 sf**  
**28 x 80 = 2240 ÷ 144 = 15.5555 (round up to even number)**

\* Slight variations in the glass may occur due to manufacturer's changes.

## Options Available ONLY as Indicated on Product Page

### FINISHES

#### FINISHES FOR HEADERS, WALL CHANNELS, AND HARDWARE

\*Colortec Paint Colors  
(see glasstec brochure  
for samples)

- Pearl White
- Platinum Grey
- Powder Grey
- Linen White
- Teal Green
- Cobalt Blue
- Royal Red
- Dusty Rose
- Caramel
- Bronze Tone
- Oil Rubbed Bronze
- Black
- Almond Tone
- Cameo Cream
- Biscuit

|                          | GCT/GCS                                | GAP/GAPW               | GP/GPW                           | GW                         | GG                     |
|--------------------------|--|------------------------|----------------------------------|----------------------------|------------------------|
| Silver Anodized Aluminum | N/A                                    | Standard               | N/A                              | Standard                   | Standard               |
| Gold Anodized Aluminum   | N/A                                    | Standard               | N/A                              | Standard                   | Standard               |
| Satin Nickel Aluminum    | N/A                                    | \$50 per door or panel | N/A                              | \$50 per door or panel     | \$50 per door or panel |
| Satin Chrome Aluminum    | N/A                                    |                        | N/A                              |                            |                        |
| Brushed Bronze           | N/A                                    |                        | N/A                              |                            |                        |
| Colortec Paint Colors*   | \$150 per door or panel                |                        |                                  | N/A                        | N/A                    |
| Custom Paint Match       | \$150 per door or panel + \$350 set up |                        |                                  | N/A                        | N/A                    |
| Polished Chrome          | Standard                               | N/A                    | Standard                         |                            |                        |
| Satin Chrome             | Standard                               | N/A                    | Standard                         |                            |                        |
| Polished Nickel          | Standard                               | N/A                    | Standard                         |                            |                        |
| Satin Nickel             | Standard                               | N/A                    | Standard                         |                            |                        |
| Polished Brass           | N/A                                    | N/A                    | N/A                              | Brass Hinges Only          |                        |
| Satin Brass              | N/A                                    | N/A                    | N/A                              | Channels Anodized Aluminum |                        |
| Antique Brass            | Custom →                               | N/A                    | Custom Quote... Call for Pricing |                            |                        |
| 24K Gold                 | Custom →                               | N/A                    | Custom Quote... Call for Pricing |                            |                        |

### DECORATIVE HANDLES

Solid 6" C-pull standard for all Brass units. Tubular 6" C-pull standard for all Aluminum units.

Prices are added to unit price for upgrade. For hardware only prices, please call for quote

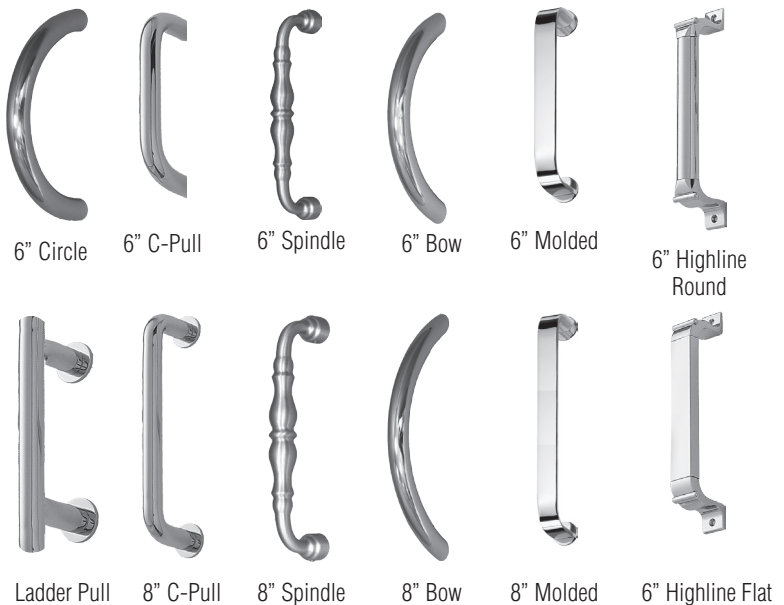

| DECORATIVE HANDLES |          |       |
|--------------------|----------|-------|
|                    | 6"       | 8"    |
| C-Pull             | Standard | \$90  |
| Spindle            | \$80     | \$100 |
| Bow                | \$80     | \$100 |
| Circle             | \$85     | N/A   |
| Molded             | \$100    | \$125 |
| Highline Round     | \$150    | N/A   |
| Highline Flat      | \$150    | N/A   |
| Ladder             | \$225    | \$250 |

### DECORATIVE KNOBS

Please see product page for knob upgrades available on the model you are ordering

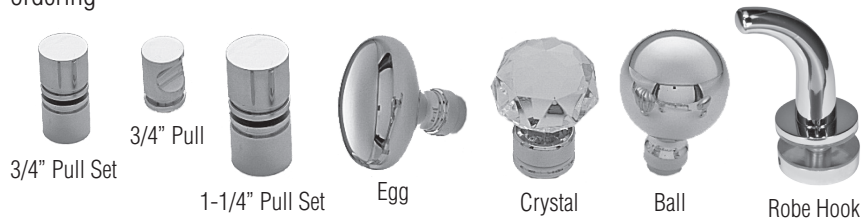

| DECORATIVE KNOBS | BYPASS DOORS | HINGE DOORS |
|------------------|--------------|-------------|
| 3/4" Pull        | N/C Option   | N/A         |
| 3/4" Pull Set    | N/A          | \$25        |
| 1-1/4" Pull Set  | N/A          | \$50        |
| Egg Knob         | N/A          | \$170       |
| Ball Knob        | N/A          | \$180       |
| Crystal Knob     | N/A          | \$225       |
| Robe Hook        | N/A          | \$90        |

# UPGRADES

| TOWEL BARS      |                                   |        |             |         |                      |                     |                           |
|-----------------|-----------------------------------|--------|-------------|---------|----------------------|---------------------|---------------------------|
| Available Sizes | 15" - 18" - 21" / 24" - 27" - 30" | Modern | Traditional | Spindle | Bow<br>18 & 24" Only | Modern Back-to-Back | 6" C-Pull Towel Bar Combo |
|                 | Bypass                            | Std.   | \$95        | \$200   | \$95                 | N/A                 | N/A                       |
|                 | Hinged Door                       | N/A    | N/A         | N/A     | N/A                  | \$250               | \$150                     |
|                 | Panel                             | \$125  | \$185       | \$300   | \$125                | \$250               | N/A                       |

**DECORATIVE TOWEL BARS:** Please see product page for towel bar upgrades available on the model you are ordering

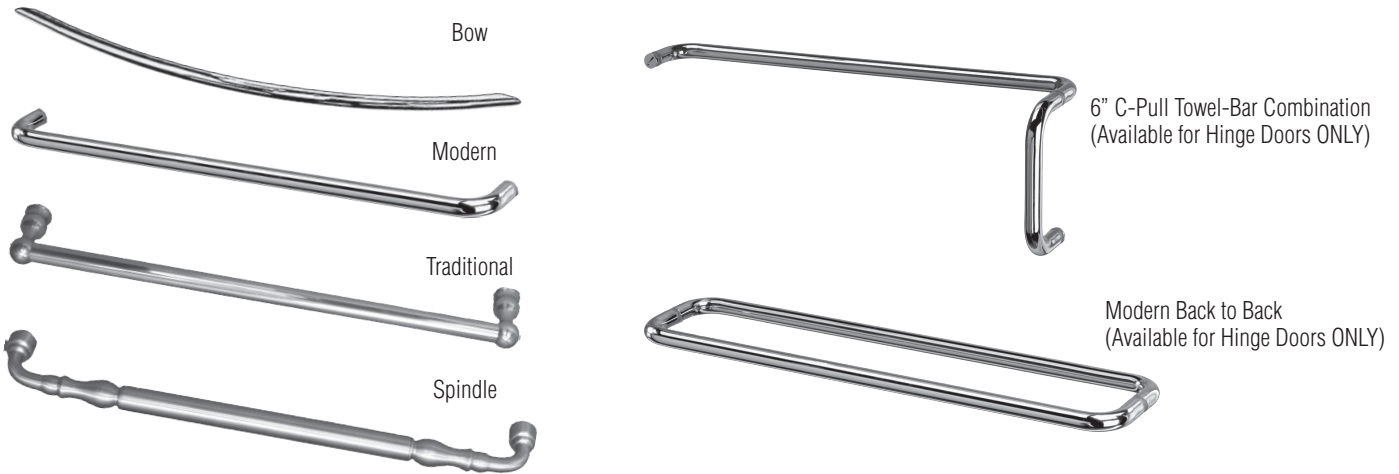

**DECORATIVE CLIPS:** Decorative clips are available for most models as an option to replace headers or wall channels. Corner clips are required for any return unit without a header.



**Stationary Clip:**

Designed to secure a fixed panel to a wall, sill, or ceiling. 3/16" clearance between glass and wall for silicone. 3/4" x 1 1/4" hole notch required. Available for 3/8" and 1/2" glass. Add \$110 per clip.

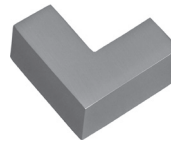

**Top 90 Degree Corner Clip:**

Mounts directly on top of panels to secure a 90 degree corner. Does not require glass fabrication holes. Available in 90 degree or mitered, 3/8" or 1/2" glass.



**90 degree Corner Clip:**

Designed to secure two panels to create a 90 degree corner. Two 5/8" diameter holes required. Available in 90 degree or mitered, 3/8" or 1/2" glass.

**90 degree glass edgework:**  
**add \$190 per clip.**  
**Mitered glass edgework:**  
**add \$190 per clip plus \$3.00 per inch**  
**which covers both sides of the miter.**

**90 degree glass edgework:**

Add \$80 per clip.  
 Mitered glass edgework: add \$80 per clip plus \$2.70 per inch which covers both sides of the miter.

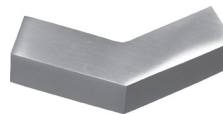

**Top Neo Angle 135 Degree Clip:**

Mounts directly on top of panel to secure a 135 degree corner. Does not require glass fabrication hole. Available in 3/8" or 1/2" glass. Add \$95 per clip.



**Neo Angle 135 Degree Clip:**

Designed to secure panels to create a 135 degree corner. Not available for special angles. Two 5/8" diameter holes required. Available for 3/8" or 1/2" glass.

**Add \$190 per clip.**

**A REVOLUTIONARY TREATMENT FOR GLASS**

The optional Diamond – Fusion treatment helps protect the glass, from the build up of soap scum and hard water deposits and reduces the cleaning time by at least 50%. Diamond – Fusion, when added during manufacturing, uses a vapor mist to fill the natural microscopic peaks and valleys in the glass, with an ultra thin optically clear durable material making the surface easier to clean and more resistant to weathering caused by the build up of soap scum and hard water deposits. Simply wipe down with a washcloth or squeegee after showering and maintenance will never be easier and the beauty will show through no matter what the water conditions are.



DIAMON-FUSION INTERNATIONAL  
*"Innovation That Ignites Business"*

| DIAMON FUSION PRICE LIST |            |
|--------------------------|------------|
| MODEL                    | PRICE LIST |
| 70                       | \$100      |
| 1627                     | \$175      |
| 1628                     | \$250      |
| 1631                     | \$325      |
| 1632                     | \$350      |
| EXTRA PANEL              | \$50       |

Mitered Glass provides a cleaner look, giving the appearance of one piece of glass. It is an upgrade available on some models as indicated on each product page. See pricing listed below.

| MODEL NO. | ADD TO LIST |
|-----------|-------------|
| 70        | \$125       |
| 1627      | \$250       |
| 1628      | \$500       |
| 1631      | \$500       |
| 1632      | \$750       |

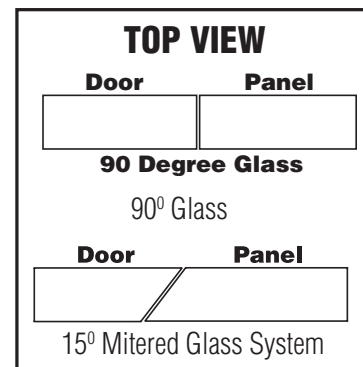



# GLASS SHELVING SYSTEMS FOR SHOWER AND HOME

NOTE: DRAWINGS  
NOT TO SCALE

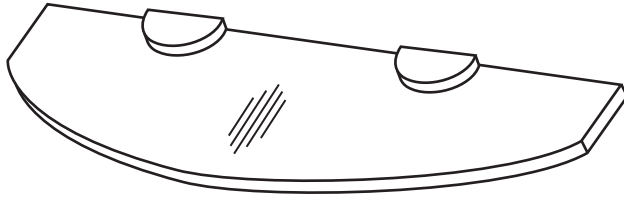

38GLSHF - RECTANGLE .5 RAD (4 X 12)  
(CX = CHROME / SN = SATIN NICKEL)

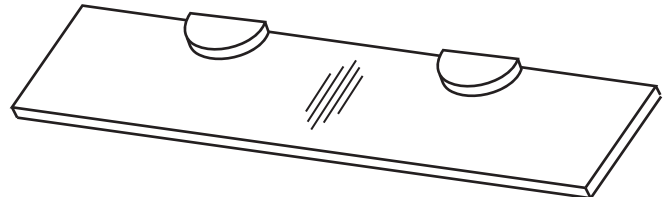

38GLSHF - RECTANGLE (4 X 12)  
(CX = CHROME / SN = SATIN NICKEL)

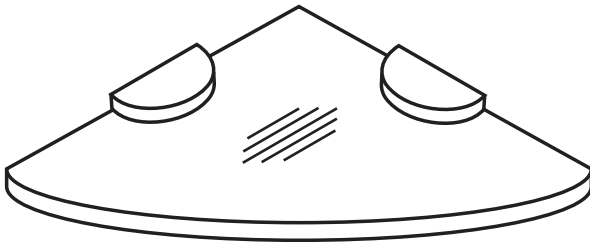

38GLSHF - RECT. CORNRAD .75  
(CX = CHROME / SN = SATIN NICKEL)



38GLSHF - TRIANGLE  
(CX = CHROME / SN = SATIN NICKEL)

| MODEL NUMBER             | DESCRIPTION   |    | FINISH | LIST    |
|--------------------------|---|----|--------|---------|
| 38GLSHF - CPRNRAD .75-CX | 3/8" TEMP CORNER .75 RAD SET 8 X 8 - CHROME           | EA | CX     | \$50.00 |
| 38GLSHF - CPRNRAD .75-SN | 3/8" TEMP CORNER .75 RAD SET 8 X 8 - SATIN NICKEL     | EA | SN     | \$50.00 |
| 38GLSHF - RECTANGLE - CX | 3/8" TEMP RECTANGLE SET 4 X 12 - CHROME               | EA | CX     | \$38.00 |
| 38GLSHF - RECTANGLE - SN | 3/8" TEMP RECTANGLE SET 4 X 12 - SATIN NICKEL         | EA | SN     | \$38.00 |
| 38GLSHF - RECTRAD - 5-CX | 3/8" TEMP RECTANGLE .5 RAD SET 4 X 12 - CHROME        | EA | CX     | \$45.00 |
| 38GLSHF - RECTRAD - 5-SN | 3/8" TEMP RECTANGLE .5 RAD SET 4 X 12 - SATIN NICKEL  | EA | SN     | \$45.00 |
| 38GLSHF - TRIANGLE - CX  | 3/8" TEMP TRIANGLE SET 8 X 8 X 11 5/16 - CHROME       | EA | CX     | \$40.00 |
| 38GLSHF - TRIANGLE - SN  | 3/8" TEMP TRIANGLE SET 8 X 8 X 11 5/16 - SATIN NICKEL | EA | SN     | \$40.00 |



# CONTACTS

## CENTURY LOCATIONS

### Headquarters

Peter Raleigh: National Sales Manager  
Woodland Park, NJ 07424  
Phone: 973-785-4290  
Fax: 973-785-0777

### New Jersey

250 Lackawanna Avenue  
Woodland Park, NJ 07424  
Phone: 973-785-4290  
800-524-2578  
Fax: 973-785-0777

### Branch Locations

#### Illinois

830 W. Foster Avenue  
Bensenville, IL 60106  
Phone: 630-616-0120  
Fax: 630-616-0121

#### Maryland

11890 Old Baltimore Pike  
Beltsville, MD 20706  
Phone: 301-937-1257  
Fax: 301-937-1383

## CENTURY SALES STAFF

### NJ North of Rt. 195, Rockland County, NY

Michael Russo  
Phone: 973-214-5692 Fax: 973-785-0777

### NJ South of I95 Delaware, Northern Maryland

RG Marketing  
Phone: 410-787-8744 Fax: 410-787-9449

### NY, Staten Island, Bronx, Westchester, Putnam

Dick Dixon  
Phone: 631-241-3271 Fax: 631-683-4792

### Long Island, Brooklyn, Queens, Manhattan

Kevin Devers  
Phone/Fax: 631-878-5472

### MD, VA & DC

David Dixon  
Phone: 703-803-8385 Fax: 703-802-7986

### NYS East of Syracuse, Western CT, Western MA

Chris Gerardi  
Phone: 518-573-4310 Fax: 413-442-3265

## CENTURY SALES STAFF

### Metro Boston, Fairfield Cty, Connecticut

John Magruder  
Phone: 781-925-6530 Fax: 781-925-6533

### Maine, New Hampshire, Vermont & Northeast Mass

Phil Abbott  
Phone: 603-731-0434 Fax: 603-228-3709

### Rhode Island, S.E. Mass, Eastern Connecticut

Colin Magruder  
Phone: 781-925-6530 Fax: 781-925-6533

### Eastern Massachussets

Mark Sorenson  
Phone: 603-498-3881 Fax: 207-363-5573

### Ontario

Suzy Louw  
Phone: 585-489-0272 Fax: 905-727-5893

### Ohio, Indiana, Kentucky

Curnayn Sales  
Phone: 440-846-1280 Fax: 440-846-1283

### Florida

Pan American Sales & Marketing  
Phone: 954-693-9688 Fax: 954-693-9683

### Illinois, Wisconsin, Montana

WSC - Gregg Libby  
Phone/Fax: 414-453-6979

### Michigan

Paradise Sales  
Phone: 313-294-7450 Fax: 313-294-7484

### Utah, Colorado, Wyoming, Montana

ADD: ML Sales  
Phone: 303-644-3744 Fax: 303-644-3745

### Oregon, Washington, Idaho, Arkansas

AMSG & Associates  
Phone: 800-285-4622 Fax: 503-520-9005

### Northern California, Nevada

Thomas Ramos & Company  
Phone: 831-429-9506 Fax: 831-426-1988

### Arizona, New Mexico, Las Vegas

B&B Marketing  
Phone: 623-580-9316 Fax: 623-580-9317

### Southern California

C Group, Inc.  
Phone: 949-887-0553 Fax: 949-429-5814

Locations not listed, please call Headquarters



**Century Bathworks, Inc.™ • 250 Lackawanna Avenue • Woodland Park, NJ 07424  
973 785 4290 • 800 524 2578 • fax 973 785 0777**